

Enhancing the Seismic Response of Residential RC Buildings with an Innovative Base Isolation Technique

Belbachir, Asma; Benanane, Abdelkader; Ouazir, Abderrahmane; Harrat, Zouaoui R.; Hadzima-Nyarko, Marijana; Radu, Dorin; Isık, Ercan; Louhibi, Zouhir S. M.; Amziane, Sofiane

Source / Izvornik: **Sustainability, 2023, 15**

Journal article, Published version

Rad u časopisu, Objavljena verzija rada (izdavačev PDF)

<https://doi.org/10.3390/su151511624>

Permanent link / Trajna poveznica: <https://urn.nsk.hr/urn:nbn:hr:133:050454>

Rights / Prava: [Attribution 4.0 International](#)/[Imenovanje 4.0 međunarodna](#)

Download date / Datum preuzimanja: **2025-02-28**



GRAĐEVINSKI I ARHITEKTONSKI FAKULTET OSIJEK
Faculty of Civil Engineering and Architecture Osijek

Repository / Repozitorij:

[Repository GrAFOS - Repository of Faculty of Civil Engineering and Architecture Osijek](#)



Article

Enhancing the Seismic Response of Residential RC Buildings with an Innovative Base Isolation Technique

Asma Belbachir ¹, Abdelkader Benanane ¹, Abderrahmane Ouazir ^{1,2}, Zouaoui R. Harrat ^{3,4,*} ,
Marijana Hadzima-Nyarko ^{5,6} , Dorin Radu ⁶ , Ercan Işık ⁷ , Zouhir S. M. Louhibi ⁸ and Sofiane Amziane ⁴ 

¹ Laboratory of Materials and Processes of Construction, Abdelhamid Ibn-Badis University, Mostaganem 27000, Algeria

² Department of Civil Engineering, College of Engineering, University of Hail, Hail 2240, Saudi Arabia

³ Laboratoire des Structures et Matériaux Avancés dans le Génie Civil et Travaux Publics, University of Djillali Liabes, Sidi Bel-Abbes 22000, Algeria

⁴ Institut Pascal, UMR 6602, Clermont Auvergne University, CNRS, Sigma, 63000 Clermont-Ferrand, France

⁵ Department of Civil Engineering, Josip Juraj Strossmayer University of Osijek, Vladimira Preloga 3, 31000 Osijek, Croatia

⁶ Faculty of Civil Engineering, Transilvania University of Braşov, Turnului Street No. 5, 500152 Braşov, Romania

⁷ Department of Civil Engineering, Bitlis Eren University, 13100 Bitlis, Turkey

⁸ Laboratory of Civil Engineering and Environment, Djillali Liabes University, Sidi Bel-Abbes 22000, Algeria

* Correspondence: zouaoui.harrat@dl.univ-sba.dz

Abstract: The prediction of the magnitude and impact of forthcoming earthquakes remains an elusive challenge in the field of science. Consequently, extensive research efforts have been directed toward the development of earthquake-resistant design strategies aimed at mitigating building vibrations. This study focuses on the efficacy of fluid viscous dampers (FVDs) in augmenting the seismic response of a low-rise residential reinforced-concrete building, which is base-isolated, using high-damping rubber bearings (HDRBs). The structural analysis employs a non-linear approach, employing ETABS v16 software for building modeling and conducting non-linear dynamic analysis using artificial accelerograms specific to Algeria. Three distinct connection configurations to the building's base are investigated: (1) a fixed-base structure; (2) a structure isolated by HDRBs; and (3) a structure isolated utilizing a novel parallel arrangement of HDRBs in conjunction with FVDs. Comparative evaluation of these configurations reveals noteworthy findings; the results demonstrate that the base isolation system, comprising HDRBs and FVDs, significantly diminishes the base shear force by over 80% and reduces acceleration by 54% while concurrently increasing displacement by 47%. These findings underscore the effectiveness of incorporating FVDs in conjunction with HDRBs as a means to enhance the seismic response of reinforced concrete buildings. This study showcases the potential of such structural analyses to contribute to the development of earthquake-resistant design approaches, providing valuable insights for architects and engineers involved in constructing resilient buildings in seismically active regions.

Keywords: seismic isolation; base shear; inter-story displacement; high-damping rubber bearings; fluid viscous dampers; artificial accelerogram



Citation: Belbachir, A.; Benanane, A.; Ouazir, A.; Harrat, Z.R.; Hadzima-Nyarko, M.; Radu, D.; Işık, E.; Louhibi, Z.S.M.; Amziane, S. Enhancing the Seismic Response of Residential RC Buildings with an Innovative Base Isolation Technique. *Sustainability* **2023**, *15*, 11624. <https://doi.org/10.3390/su151511624>

Academic Editor: Muhammad Junaid Munir

Received: 3 July 2023

Revised: 23 July 2023

Accepted: 25 July 2023

Published: 27 July 2023



Copyright: © 2023 by the authors. Licensee MDPI, Basel, Switzerland. This article is an open access article distributed under the terms and conditions of the Creative Commons Attribution (CC BY) license (<https://creativecommons.org/licenses/by/4.0/>).

1. Introduction

Earthquakes have long been a significant natural disaster that poses challenges to humanity. Over the past 20 years, numerous devastating earthquakes have occurred, with the most recent one taking place in Turkey and Syria on 6 February 2023. These seismic events have resulted in a growing number of fatalities due to building collapse and structural damage. As a result, professionals and scientists have been compelled to develop innovative procedures and methods to protect buildings and structures from the destructive forces of dynamic loading, thereby reducing reaction quantities, such as velocities, deflections, and forces.

There are two primary techniques employed in ensuring earthquake resistance in structure design and construction: (i) the conventional earthquake-resistant design approach; and (ii) the approach based on seismic isolation. The conventional approach focuses on strengthening structures' ability to withstand earthquakes by incorporating features such as shear walls, braced frames, or moment-resistant frames. However, this traditional method often leads to excessive floor acceleration or significant inter-story drifts in buildings. Consequently, seismic isolation earthquake-resistant design has gained popularity, and in earthquake-prone areas around the world, the concept of base isolation is widely recognized as an effective means of protecting significant structures from intense ground motion [1–3]. Countries, such as the United States, New Zealand, Japan, China, and various European nations, have adopted these strategies as standard practices for many public and residential structures [4–6].

Base isolation techniques are employed to safeguard buildings and structures from the destructive effects of earthquakes. Several varieties of these techniques exist, each with its own advantages and disadvantages. The most common types include elastomeric bearings and sliding bearings. Elastomeric bearings, as a type of seismic isolation system, are divided into two main categories, Steel Reinforced Elastomeric Bearings (SREBs) [7] and Fiber Reinforced Elastomeric Bearings (FREBs) [8]. Within the SREB category, there are three distinct subcategories: low-damping rubber bearings (LDRBs) [9], designed for structures requiring moderate damping; high-damping rubber bearings (HDRBs) [10–12], offering higher damping capabilities for structures with specific vibration control needs; and lead-rubber bearings (LRBs) [13–16], designed for seismic isolation applications with superior energy dissipation properties.

On the other hand, sliding bearings are widely used for their ability to accommodate lateral movements caused by seismic forces. These bearings are classified into two main types, Flat Surface Sliding Bearings (FSSBs) [17] and Curved Surface Sliding Bearings (CSSBs), which include so-called friction pendulum bearings [18,19]. These base isolators are suitable for structures requiring horizontal movement with minimal resistance, allowing them to slide smoothly during seismic events; also, they are less expensive than rubber or lead-rubber bearings, but they require more maintenance and are less effective at reducing seismic forces.

High-damping rubber bearings (HDRBs) [20,21] consist of layers of rubber and steel plates with a high damping coefficient, allowing them to dissipate the energy generated by seismic waves. Compared to other types of bearings used for seismic protection [22–24], HDRBs offer several advantages in terms of effectiveness. Unlike traditional elastomeric bearings, which typically have lower damping coefficients, HDRBs can absorb a significantly higher percentage of seismic energy. This enables HDRBs to reduce the drift and acceleration of structures during an earthquake, resulting in less damage and lower repair costs. Compared to lead-rubber bearings, which can also provide high damping ratios, HDRBs have a simpler design and are easier to install and maintain. Additionally, HDRBs are more cost-effective than friction pendulum bearings, which can be expensive due to their complex design and manufacturing process. Table 1 provides a concise overview of the primary data gathered during the literature review on base isolation techniques, outlining their benefits and drawbacks.

Dampers are devices utilized to dissipate energy and mitigate the damaging effects of seismic waves on structures during an earthquake. There are several types of dampers commonly used for seismic protection, including fluid viscous dampers (FVDs), friction dampers, and yielding dampers. FVDs [25–30] utilize shear forces generated by the motion of fluid within a piston-cylinder system to dissipate energy, while friction dampers [31,32] rely on frictional forces for energy dissipation. On the other hand, yielding dampers [33,34] are designed to absorb energy through inelastic deformation. Dampers effectively reduce the inter-story displacement and acceleration of structures during an earthquake, resulting in less damage and lower repair costs. The choice of damper depends on the specific needs and requirements of the structure being protected, including factors such as the structure's

mass, frequency, and expected seismic activity. Compared to other types of dampers, such as friction dampers, FVDs offer several advantages in terms of effectiveness. They can provide higher levels of damping, allowing them to effectively reduce the displacement and acceleration of structures during an earthquake [26]. Moreover, when compared to yielding dampers, FVDs can better withstand cyclic loading and high displacement demands, making them more effective at reducing the displacement and acceleration of structures during an earthquake. FVDs are better suited for seismic protection as they can operate over a wide frequency range and are not limited to a single mode of vibration; additionally, FVDs are highly reliable and require minimal maintenance, making them a popular choice for seismic retrofitting of existing buildings. The important findings from the literature review on dampers used as a base isolation approach are fully summarized in Table 2, along with their advantages and disadvantages.

Table 1. Benefits and drawbacks of base isolation techniques.

Base Isolation		Benefits	Drawbacks
Steel Reinforced Elastomeric Bearings	HDRBs [10,11,21]	<ul style="list-style-type: none"> - Excellent energy dissipation capacity - Adjustable damping properties - Enhanced seismic performance - Increased load-carrying capacity - Can be retrofitted to existing structures. 	<ul style="list-style-type: none"> - Higher cost compared to some other base isolation techniques
	Lead–Rubber Bearings [13–15]	<ul style="list-style-type: none"> - Cost-effective solution for moderate seismic zones - Can accommodate some amount of horizontal and rotational movement - Can be retrofitted to existing structures 	<ul style="list-style-type: none"> - Limited vertical load capacity - Degradation over time due to aging and environmental factors, requiring periodic inspection and potential replacement
	Low Rubber Bearings [9]	<ul style="list-style-type: none"> - Relatively lower cost compared to other base isolation techniques - Effective isolation from ground motion 	<ul style="list-style-type: none"> - Susceptibility to creep and permanent deformation over time - Limited displacement capacity
Sliding Bearings (CCSBs)	Friction Pendulum Bearings [18,19]	<ul style="list-style-type: none"> - Relatively compact design compared to other isolation systems - Can be effective in reducing the amplification of vibrations at specific frequencies 	<ul style="list-style-type: none"> - Complex design and installation - Maintenance and potential need for periodic replacement of friction materials - Higher initial cost compared to some other base isolation techniques

Table 2. Advantages and disadvantages of dampers.

Dampers	Advantages	Disadvantages
Fluid Viscous Dampers (FVDs) [26,27]	<ul style="list-style-type: none"> - High energy dissipation capacity and excellent damping performance - Adjustable damping properties - Relatively simple design and installation compared to some other damping devices - Can be retrofitted to existing structures 	<ul style="list-style-type: none"> - Requires maintenance and inspection - Higher cost compared to other dampers
Friction Dampers [31,32]	<ul style="list-style-type: none"> - Simple and compact design - Relatively lower cost compared to some other damping devices 	<ul style="list-style-type: none"> - Limited energy dissipation capacity compared to FVDs - Susceptible to wear and aging of friction materials
Yielding Dampers [33,34]	<ul style="list-style-type: none"> - High energy dissipation capacity - Relatively simple design and installation compared to some other damping devices - Can be retrofitted to existing structures 	<ul style="list-style-type: none"> - Permanent deformations may occur after severe earthquakes - Limited effectiveness in reducing vibrations at frequencies

Previous research has predominantly focused on the combination of fluid viscous dampers with laminated rubber bearings or lead–rubber bearings in order to enhance the

performance of base-isolated structures [35–39]. However, it is important to acknowledge that these combinations have limitations, specifically in terms of their limited vertical load capacity. Consequently, it may not be suitable for structures with high vertical loads or significant vertical load requirements. Moreover, sustainability emerges as a critical concern since the FVD-LRB combination can experience degradation over time due to aging and environmental factors, thereby diminishing its effectiveness, and in order to tackle these challenges and ensure the long-term durability and desired performance of the system, it is imperative to conduct periodic inspections and consider potential replacements.

To address these limitations and provide a novel alternative solution, this study proposes a novel seismic protection system for structures involving a parallel arrangement of fluid viscous dampers and high-damping rubber bearings, a combination that has not been previously reported or explored in the literature. Fluid viscous dampers are utilized for their ability to dissipate energy via viscous fluid flow, while high-damping rubber bearings are incorporated for their notable advantages over other base isolation methods, including high damping capacity, a broad frequency range, design flexibility, and excellent integration capabilities [40,41].

In our research, we conduct analytical modeling of structures connected to the base through three scenarios: (1) fixed-base; (2) isolated by HDRBs alone; and (3) isolated by a novel parallel arrangement of HDRBs + FVDs. By integrating these two distinct technologies in a parallel arrangement, the proposed system aims to synergistically enhance their performance characteristics and offer a more robust and efficient seismic protection solution.

Through our innovative approach of combining FVD with HDRB, we strive to address the limitations of existing methods and contribute to advancing the field of earthquake-resistant structural design. The enhanced seismic performance exhibited by this novel combination holds significant promise for creating more resilient and sustainable base-isolated structures when faced with seismic events. This analysis will encompass various seismic responses, such as base shear force, displacements, and acceleration, providing comprehensive and detailed insights.

2. Modeling of the Structure

The construction used in this study is a residential reinforced-concrete building with an (R + 2) type structure and a basement, with three forms of connection at the base: (1) fixed; (2) HDRB isolated; (3) HDRB + FVD isolated.

The structure is situated in the Wilaya of Boumerdès (Algeria). The location is classed as a high seismic activity zone (zone 3) by the Algerian Earthquake Regulations [42].

The structure, as shown in Figures 1 and 2, is constructed on firm ground. The sections used for the columns are (40 × 40) cm and (30 × 40) cm for both principal and secondary beams that are in the X and the Y directions, respectively. In order to evaluate how well the isolation system (HDRB + FVD) works at absorbing the total seismic intensity without being impeded by shear walls, they are not modeled in the structure.

During our analysis, we employed a combination of finite elements to accurately model the structural behavior of the building. For the vertical members, such as beams and columns, we used “Frame Elements” designed to resist axial, shear, and bending forces. Additionally, we utilized “Shell Elements” for the floor and roof slabs to capture their bending and membrane behavior. This combination of elements provided a comprehensive representation of the structural response to different loads and conditions.

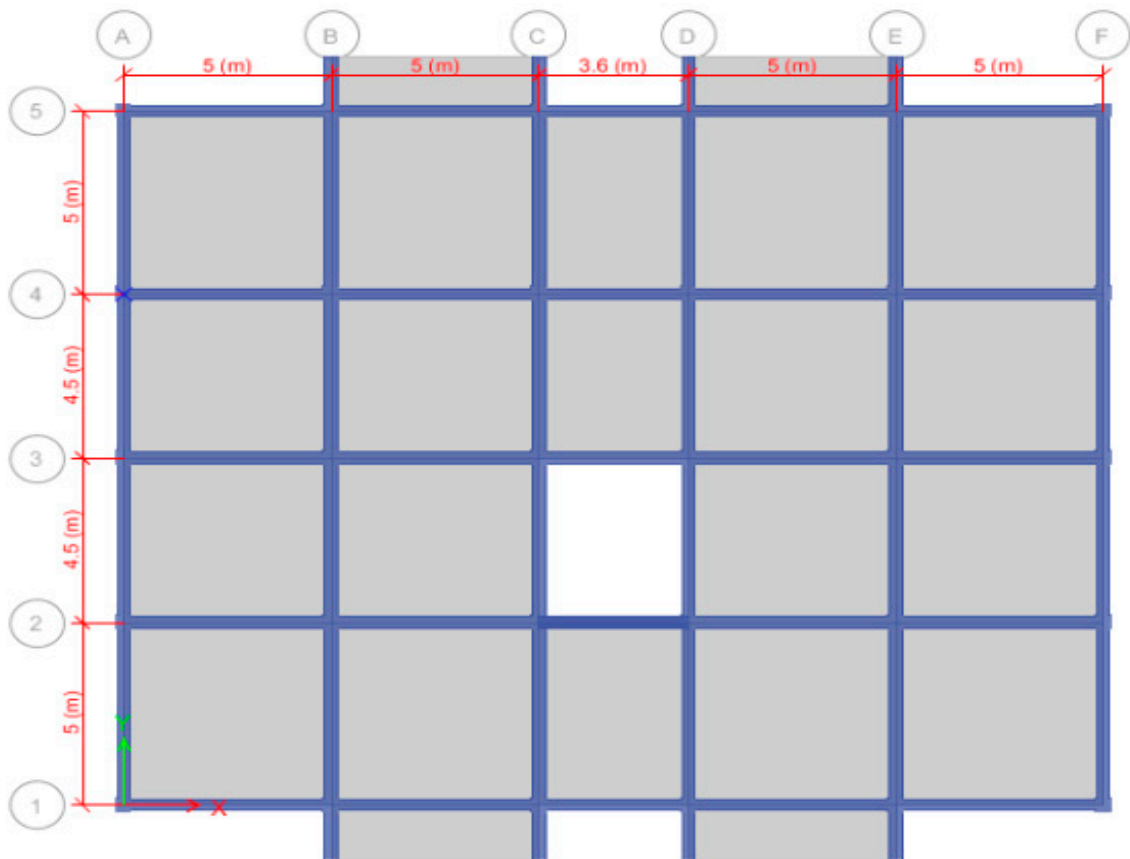

Figure 1. Plan view of the structure.

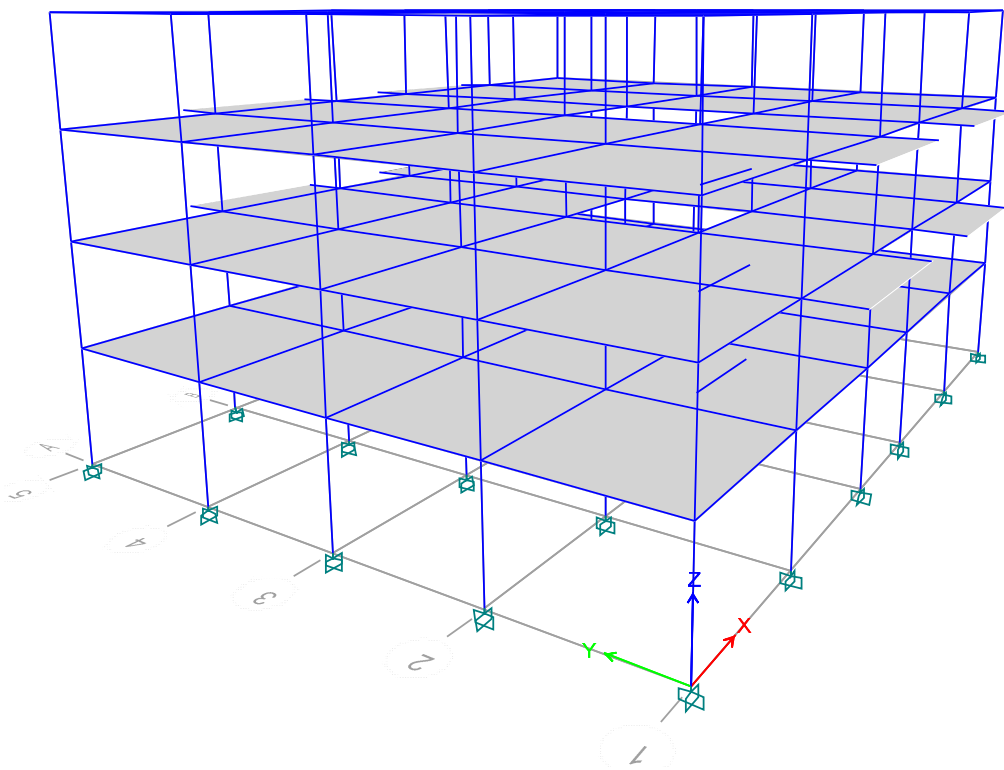

Figure 2. The 3D view of the structure (Fixed2-base).

2.1. Geometrical Characteristics of the Building

The dimensions of the construction are as follows:

- Level height: 3.06 m;
- Basement height: 3.40 m;
- Building height: 12.58 m;
- Building length: 23.6 m;
- Building width: 19 m.

2.2. Material Characteristics

In our analysis, the concrete selected to model the structure exhibits a compressive strength of $f_{c28} = 25$ MPa and a Poisson's ratio of $\nu = 0.2$. To estimate the elastic constant E_c of the concrete, we employed the following constitutive relation [43]:

$$E_c = 11,000 \sqrt[3]{f_{c28}} \quad (1)$$

where E_c represents the elastic constant of the concrete in MPa, and f_{c28} denotes the compressive strength at 28 days in MPa. The shear modulus can be calculated by the following relation [43]:

$$G = \frac{E_c}{2(1 + \nu)} \quad (2)$$

As concrete reinforcements, we utilized FeE400 steel for the longitudinal reinforcements and FeE215 steel for the transverse reinforcements. These steel grades correspond to specific yield strengths of the steel bars and are chosen based on their mechanical properties and suitability for the intended structural design.

Therefore, the material properties used in our analysis are as follows:

- Concrete's compressive strength: $f_{c28} = 25$ MPa;
- Concrete's modulus of elasticity: $E_c = 32,164$ MPa;
- Concrete's shear modulus: $G = 13401$ MPa;
- Poisson's ratio: $\nu = 0.2$;
- Yield strength of longitudinal steel = 400 MPa;
- Yield strength of transversal steel = 215 MPa.

3. Base Isolation System

3.1. HDRB

The high-damping rubber bearing (HDRB) is a commonly used isolator in retrofit projects. It is selected for investigation in this study due to its combination of high vertical stiffness, low horizontal stiffness, and moderate energy dissipation capabilities. These features make it a suitable choice for the proposed research.

Many researchers dealt with high-damping rubber bearings; Chen et al. [44] and Xue et al. [45] performed vertical compression tests and horizontal shear tests to evaluate the energy dissipation effect of the designed HDRB. Their findings demonstrated a favorable energy dissipation effect. Dong et al. [46] investigated the shear performance of HDRB by analyzing the influence of shear strain and vertical compressive stress through compression-shear performance tests. They also improved the restoring force model of the bearing with reasonable accuracy. Wang [47] conducted studies on the mechanical properties of five thick rubber bearings with varying shape factors and diameters. Their research led to the formulation of a design method for anti-buckling low-frequency seismic isolation bearings based on the summarized law of vertical stiffness parameters of new thick rubber bearings. Li et al. [48] carried out extensive experimental studies on various aspects of thick rubber bearings, including shear stiffness, vertical stiffness, deformation performance, fatigue performance, creep performance, and aging performance, focusing on the second shape factor of 1.85. Overall, the collective research from scholars worldwide highlights that thick rubber bearings offer advantages over ordinary rubber bearings, with lower vertical

stiffness and superior vertical isolation performance. This feature helps prevent adverse resonance effects resulting from the vertical period of vibration coupling with the structure. Tiong et al. [20] modeled a real-size HDRB and tested it on three types of structure in terms of vertical loading. HDRB was found to offer a considerable reduction in base shear and floor acceleration, which is significantly lower than the existing classification. Ghrewati et al. [49] formulated a rubber mixture specifically designed for high-damping rubber bearing (HDRB) seismic base isolation systems to withstand seismic loads. They conducted a comparative analysis with international companies' brochures and found that the results fell within the satisfactory range of the parametric values specified in the manufacturing design brochure. This outcome validates the suitability of the developed rubber mixture, providing strong motivation for local manufacturing of seismic isolators at affordable prices.

In the isolation technique employed for our study, a total of 30 structural isolators are placed in a concentric pattern beneath each post of the building. This arrangement aims to optimize the seismic response of the structure. Figure 3 illustrates the idealized non-linear force-displacement curve specific to HDRBs, which characterizes their behavior under seismic loading.

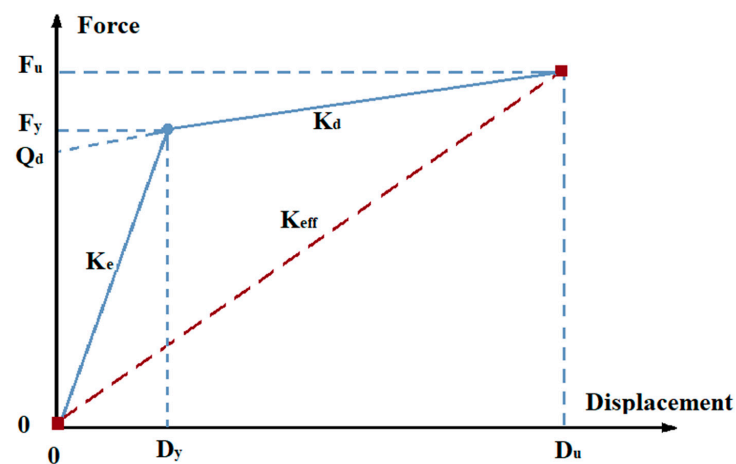

Figure 3. Idealized non-linear force-displacement curve for HDRBs [22].

To determine the geometric and mechanical parameters of the HDRBs subjected to the most unfavorable load, various seismic guidelines [50–54] are used, and the calculations are presented in Table 3. These parameters are essential for accurate modeling and analysis. It is worth noting that the additional supports in the system are dimensioned in a similar manner for ease of implementation.

Figure 4 provides an illustration of the components and dimensions of the HDRBs employed in this study:

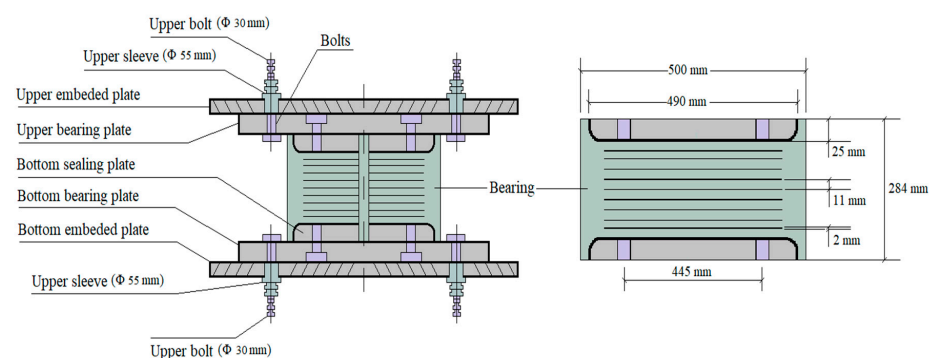

Figure 4. HDRB dimensions [21].

Table 3. HDRB system properties.

K_{eff} [kN/m]: Effective stiffness	463
T_c [mm]: Thickness of a single layer of rubber	11
T_s [mm]: Thickness of steel frets	2
H [mm]: Total height of the isolator	284
D [mm]: Diameter of the isolator	500
K_e [kN/m]: Elastic stiffness	1039
K_v [kN/m]: Vertical stiffness	605,917
K_d [kN/m]: Post-elastic stiffness	318
F_y [kN]: Yield strength	39
D_y [m]: Yield displacement	0.038
Q_d [kN]: Characteristic strength	27

In the literature [55–57], the hysteric behavior exhibited by elastomeric bearings is commonly represented by using two parallel springs. Specifically, this model incorporates a uniaxial hysteretic spring alongside a non-linear elastic spring. The first spring accurately captures hysteresis loops bounded by two straight lines, while the latter modifies the shape of these lines, resulting in two limiting curves.

When analyzing structures with HDRBs in software such as ETABS [58], a non-linear link element is used to model the behavior of these rubber bearings. The non-linear behavior of HDRBs arises from the fact that their response is not directly proportional to the applied load or deformation, especially during large displacements. The link element accounts for this nonlinearity in the analysis.

The link element is a specialized connector used to connect structural elements with HDRBs or other non-linear elements. It enables the software to accurately simulate the behavior of the HDRBs under different loading conditions. Here's a simplified explanation of how the non-linear link for HDRBs works in ETABS:

1. **Force-Displacement Relationship:** The non-linear link incorporates the force-displacement relationship of the HDRB. This relationship describes how the rubber bearing responds to different levels of displacement (compression or elongation). In the case of HDRBs, the force-displacement curve typically exhibits a softening behavior, where the resistance reduces as the displacement increases;
2. **Hysteresis:** HDRBs exhibit hysteresis, which means that the force-displacement relationship is different during loading and unloading cycles. The link element should account for this hysteretic behavior to accurately simulate the energy dissipation in the rubber bearing;
3. **Time-Step Integration:** Since the HDRB response is non-linear, the numerical integration methods used in the analysis must be capable of handling this nonlinearity. ETABS uses algorithms such as Newmark or HHT (Hilber–Hughes–Taylor) to perform time-step integration for non-linear systems;
4. **Material Properties:** The link element requires the input of HDRB properties, such as stiffness and yield strength. These properties can be obtained from material testing or supplier data.

By incorporating the non-linear link element in the analysis, ETABS can provide a more realistic representation of the structure's behavior when subjected to dynamic loads and accurately predict the response of the building with high-damping rubber bearings.

To model an HDRB in ETABS v16 software [58], the following steps can be followed:

- (i) **Definition of HDRB properties:** Begin by defining the properties of the HDRB based on the calculations presented in Table 3. While some properties can be obtained

- from the manufacturer's data, others may need to be dimensioned using the cited guidelines [50–54];
- (ii) Assigning HDRBs to the supports: In ETABS, select the support that requires seismic isolation. Then, navigate to the “Assign > Property” menu and choose the HDRB property defined in step (i);
 - (iii) Defining the HDRB link: To connect the isolated supports to the structure, define a link element with the HDRB properties. In ETABS, access the “Define > Link Property” menu and select the HDRB properties defined in step (i);
 - (iv) Define non-linear hinge properties: HDRBs exhibit non-linear behavior, so it is necessary to define non-linear hinge properties to accurately represent their response. In ETABS, access the “Define > Non-linear Link Properties” menu and define the non-linear hinge properties. This step ensures that the software can accurately model the behavior of the HDRB;
 - (v) Conduct structural analysis: Once the HDRBs have been accurately specified and assigned (See Figure 5), perform a non-linear analysis to evaluate the structure. This analysis utilizes the HDRB properties established in step (i) and incorporates the non-linear hinge properties determined in step (iv), enabling an accurate representation of the HDRB's behavior.

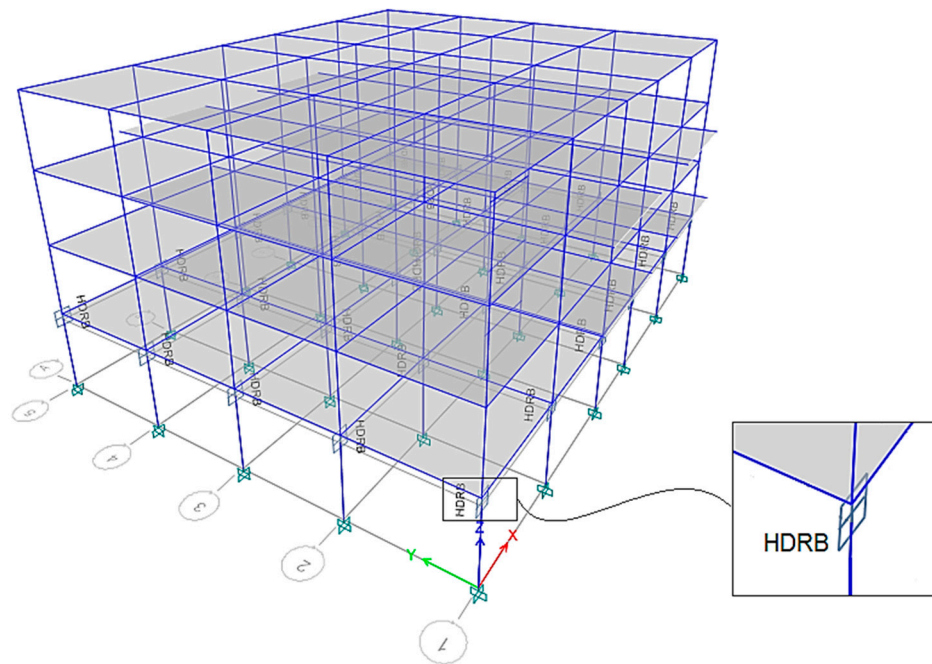

Figure 5. The 3D view of an HDRB isolated structure.

3.2. FVD

Experimentations on fluid viscous dampers involve testing their performance under various loading conditions to validate their effectiveness in reducing structural vibrations and enhancing seismic resilience in buildings and structures. Guler and Alhan [25] shed light on the effectiveness of non-linear fluid viscous dampers (FVDs) in seismically isolated buildings. The results demonstrate that the quantity of supplemental damping and the level of non-linearity play crucial roles in efficiently minimizing base displacement. Though the non-linear supplemental dampers can induce superstructure response amplification in far-field earthquakes, this negative effect can be decreased or even avoided by employing appropriate combinations of non-linearity level and supplemental damping. Karimi and Genç [26] analyzed the effectiveness of combined fluid viscous dampers with lead-core rubber bearings (LCRBs) in protecting a base-isolated high-rise building against resonance. The outcomes showed that the strength of the resonance phenomena may be minimized in a base-isolated high-rise building combining FVD and base isolation systems. Tiwari

et al. [27] assessed the usefulness of non-linear fluid viscous dampers (FVDs) for enhancing high-rise RC buildings' seismic performance. According to the findings, FVDs are very effective at lowering storey drift and increasing displacement. In their experimental research, He et al. [59] investigated the seismic behavior of a precast frame structure incorporating a viscous damper. They created two precast concrete frame specimens, one with a viscous damper (PCFV) and the other without (PCF). These specimens underwent dynamic reversed cyclic loading tests. The outcomes of the experiments revealed that the inclusion of the viscous damper enhanced the dynamic bearing capacity of the frames.

In this study, a fluid viscous damper (FVD) manufactured by Taylor Devices, Inc. headquartered in North Tonawanda, NY, USA [60] is employed. The placement of the FVD in buildings is illustrated in Figure 6, showcasing its typical location within the structural system. The FVD used in this work, depicted in Figure 7, comprises several components, including a stainless-steel piston, a steel cylinder divided into two chambers by the piston head, a compressible hydraulic fluid (silicone oil), and an accumulator to facilitate smooth, fluid circulation.



Figure 6. FVD's location in the isolated building [60].

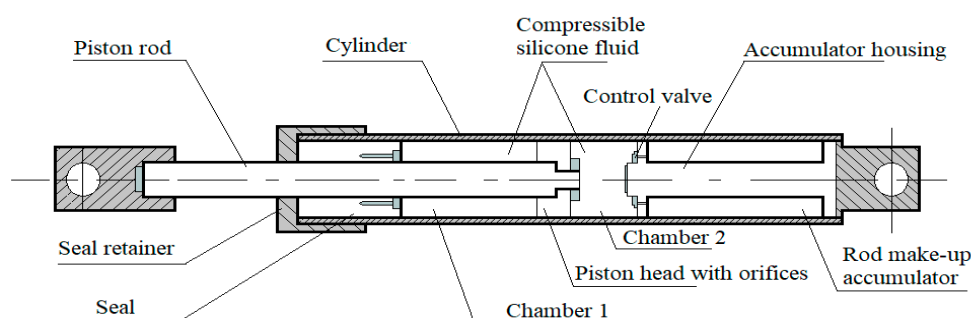

Figure 7. Longitudinal section of a typical fluid viscous damper [40].

To incorporate the FVD into the structural analysis, ETABS software [58] is utilized. The damper is modeled within the software, as shown in Figure 8. The rheological model commonly used to represent the behavior of fluid viscous dampers is the “viscous damping model” [61]. This typically contains both a spring element and a damper element. The combination of these elements allows for an accurate representation of the behavior of the fluid viscous damper under different loading conditions.

- **Spring Element:** The spring represents the stiffness of the fluid viscous damper. It models the force-displacement relationship that is present when the damper is subjected to axial loads or deformations. The spring element accounts for the linear elastic

behavior of the damper, meaning that it resists deformation proportionally to the applied force;

- **Damper Element:** The dashpot represents the viscous damping behavior of the fluid viscous damper. It models the force–velocity relationship, meaning that it generates a damping force proportional to the relative velocity between the damper’s components. The damper element is responsible for dissipating energy and providing damping during dynamic events.

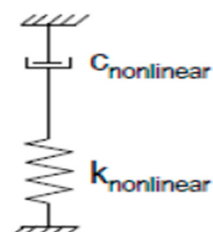

Figure 8. Damper element in ETABS software.

By combining the spring and the dashpot, the fluid viscous damper model can accurately capture the interaction between stiffness and damping, which is crucial for understanding the behavior of the damper in a structural system.

In structural analysis software such as ETABS, these elements are usually included as part of a specialized “fluid viscous damper” component or as part of a larger library of seismic isolation and energy dissipation devices. Engineers can then assign appropriate properties (such as spring stiffness, damping coefficient, and yield strength) to these elements based on the specific characteristics of the fluid viscous dampers being used in the structure. Table 4 provides a summary of the characteristics and properties of the FVD used in this study. These details are essential for accurately representing the behavior of the damper within the analysis.

Table 4. FVD system properties.

L [m]: Damper length	0.787
F [kN]: Damper force	250
KD [kN/m]: Stiffness	110,285
CD [kN.s/m]: Damping coefficient	301
V [m/s]: Velocity	0.538
α : Damping exponent	0.3

Where:

$$F = C_D \cdot V^\alpha \quad (3)$$

After a comprehensive evaluation process, we thoroughly examined different arrangements and setups for the fluid viscous dampers with the aim of achieving optimal performance and effectively mitigating structural vibrations. Our investigations involved testing various placement options while considering practical limitations and engineering principles. Through meticulous analysis and rigorous testing, we determined that positioning the fluid viscous dampers at the edges of the structure produced the most favorable outcomes. This configuration allowed us to maximize the efficiency of damping and minimize the transmission of vibrations throughout the structure. Consequently, it significantly reduced the structural response and improved the system’s stability under dynamic loading conditions. Furthermore, locating the dampers at the edges provided several benefits. It facilitated a more even distribution of damping forces across the structure and reduced the likelihood of localized stress concentrations. Additionally, this arrangement aligned well with the design concept, ensuring a seamless integration of the dampers within the

structure. Figure 9 shows the location of the dampers used in our study, and Figure 10 shows a 3D view of a structure isolated by a parallel arrangement of HDRB+FVD

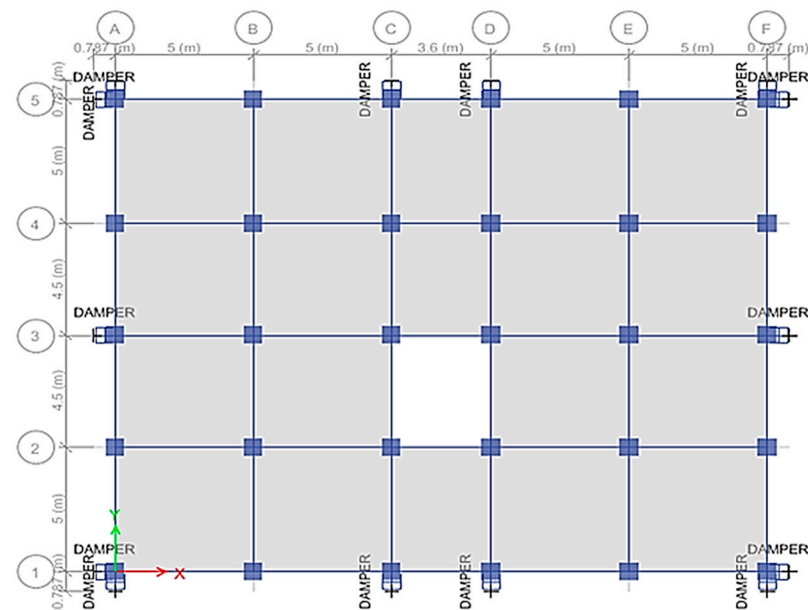

Figure 9. Plan view of damper placement on upper basement.

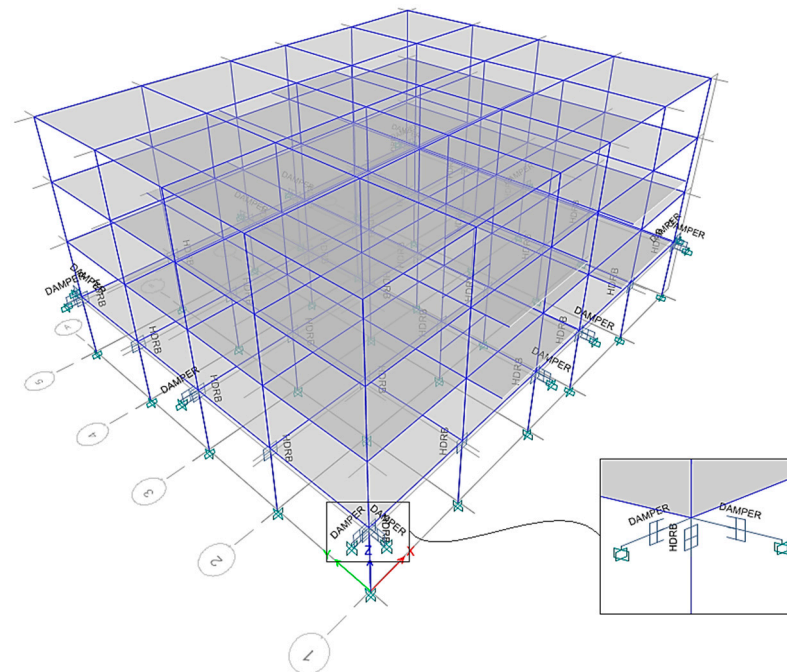

Figure 10. The 3D view of an HDRB+FVD isolated structure.

4. Accelerogram

For our research, seven accelerograms were obtained from the National Earthquake Engineering Center [62] and recorded at seven different stations during the Boumerdès earthquake (21 May 2003), with a magnitude of 6.8 on the Richter scale. The seven accelerograms were put into SeismoSoft v21 Software [63] and then converted to obtain the equivalent artificial accelerograms. Figure 11 illustrates an example of an artificial accelerogram generated for the city of Dar El Beida (Algeria).

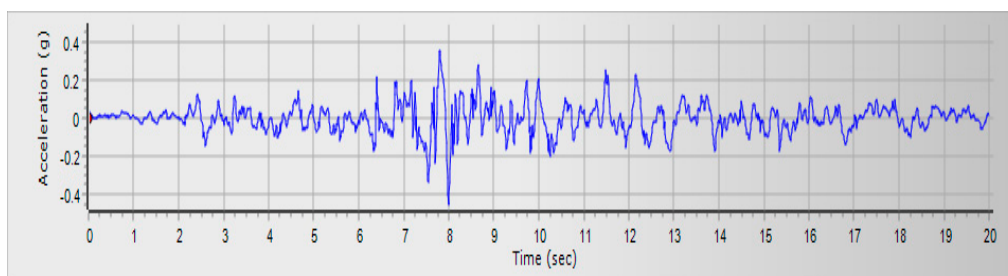

Figure 11. Example of an artificial accelerogram generated for the city of Dar El Beïda.

Haido [64] highlighted the importance of response spectrum analysis for evaluating the seismic resistance of reinforced concrete buildings. This study focused on developing a new design spectrum and dynamic analysis for reinforced concrete multi-storey buildings. It considered seismic risks and soil properties and investigated the influence of concrete section reduction factors. In agreement with this study and according to the requirements specified in Eurocode 8 (EC8) [43], the elastic response spectrum utilized in this study corresponds to the Boumerdès region. The spectrum compatibility verifications, which are associated with the selected set of accelerograms, are presented in Figure 12. These verifications are conducted using a viscous equivalent damping of 5%. The same damping value is employed both for determining the elastic response spectrum and for determining the spectra related to the recorded accelerograms. Furthermore, in accordance with Eurocode 8, if the response is derived from a minimum of seven non-linear time-history analyses, the average of the values obtained from all these analyses should be utilized. This approach ensures a robust and representative estimation of the structural response under seismic loading conditions.

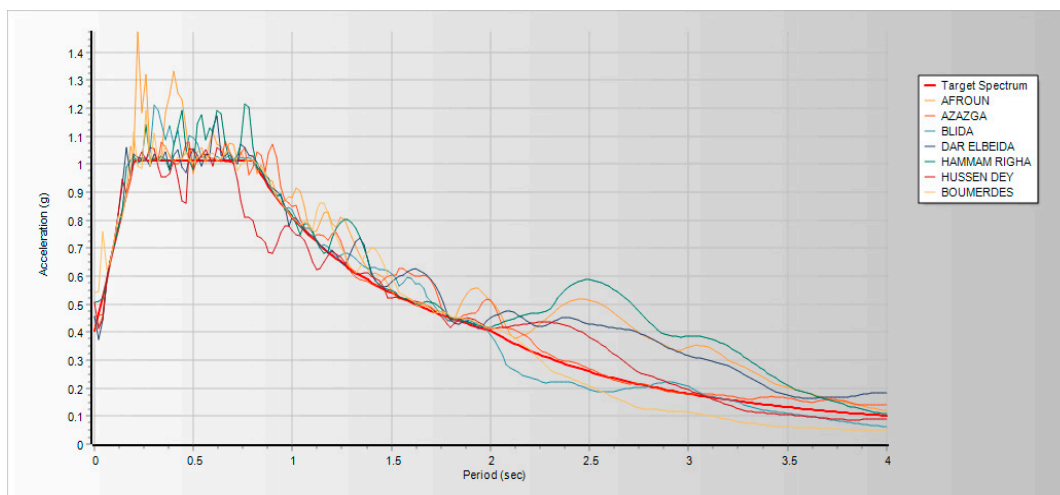

Figure 12. Code-conforming spectrum-compatibility check of the selected records according to EC8.

5. Results and Discussion

The current study includes an analysis of an (R + 2) residential reinforced concrete building with a basement based on the three forms of connection to the base. The following are this study's objectives:

- To use ETABS model software and SeismoSoft to model and evaluate fixed-base and base-isolated structures and investigate the impact of seismic forces on the structure;
- To design and test high-damping rubber bearings and fluid viscous dampers as a base isolation system;
- To study the behavior of isolated RC buildings in Algerian areas with higher seismic activity.

5.1. Modal Analysis

This study reveals that seismic isolation has a significant impact on the fundamental period of the isolated structure compared to the fixed-base structure. The fundamental period increases substantially when using seismic isolation techniques. The first mode of vibration exhibits a noticeable change, with the period increasing from 0.77 s in the fixed-base structure to 2.44 s in the isolated structures, as indicated in Tables 5 and 6. This elongation of the period demonstrates the enhanced flexibility of the structure and the effectiveness of the isolation system.

Table 5. Dynamic properties of the fixed-base structure.

Case	Mode	Period (s)	ΣM_X	ΣM_Y
Modal	1	0.77	0	0.863
Modal	2	0.744	0.8606	0.863
Modal	3	0.706	0.8658	0.863
Modal	4	0.238	0.8658	0.9615
Modal	5	0.232	0.9623	0.9615
Modal	6	0.22	0.9623	0.9615

Table 6. Dynamic properties of the structure with HDRB isolation system.

Case	Mode	Period (s)	ΣM_X	ΣM_Y
Modal	1	2.44	0	0.9991
Modal	2	2.436	0.9963	0.9991
Modal	3	2.304	0.9993	0.9991
Modal	4	0.354	0.9993	1
Modal	5	0.342	1	1
Modal	6	0.333	1	1

In terms of modal participation factor, the fixed-base model shows that the response is influenced by up to the fifth mode, with a modal participation factor of more than 96 percent. However, for both the HDRB isolation and HDRB + FVD isolation models, the response is predominantly governed by the first mode, with a modal participation factor of 99 percent. This indicates that the contribution of higher modes is negligible in the isolated models, which is an important finding in structural dynamic analysis. It suggests that the higher modes have minimal influence on the seismic response of the isolated structures, unlike in the case of fixed-base structures.

The results of modal analyses for the HDRB + FVD isolation system, presented in Table 7, are consistent with the findings in Table 6. Modal analyses, which are based on mass and stiffness without considering damping, yield the same results for both Tables.

Table 7. Dynamic properties of the structure with HDRB+FVD isolation system.

Case	Mode	Period (s)	ΣM_X	ΣM_Y
Modal	1	2.44	0	0.9991
Modal	2	2.436	0.9963	0.9991
Modal	3	2.304	0.9993	0.9991
Modal	4	0.354	0.9993	1
Modal	5	0.342	1	1
Modal	6	0.332	1	1

5.2. Dynamic Analysis

High-damping rubber bearings are designed with a specific elastomeric component that exhibits a critical damping range from 10 to 20 percent. The damping properties of these bearings are influenced by factors such as the rubber vulcanization technique and the curing process. The elastomeric material used in high-damping bearings is capable

of dissipating significant amounts of energy, which is reflected in the formation of large hysteresis loops in the device's behavioral law. These hysteresis loops indicate the bearing's ability to absorb and dissipate energy effectively.

One of the distinguishing characteristics of high-damping bearings is their ability to withstand substantial shear deformations, which exceed the capabilities of ordinary elastomers. This is due to the specific properties of the high-damping elastomer. Under lateral forces, the bearing exhibits non-linear behavior, as illustrated in Figure 13a,b. Initially, for small shear deformations, the bearing has relatively high lateral stiffness. However, as the shear deformations increase, the stiffness of the bearing decreases significantly. This non-linearity in stiffness allows the bearing to provide effective energy dissipation and accommodate large deformations, enhancing its overall performance in mitigating seismic forces.

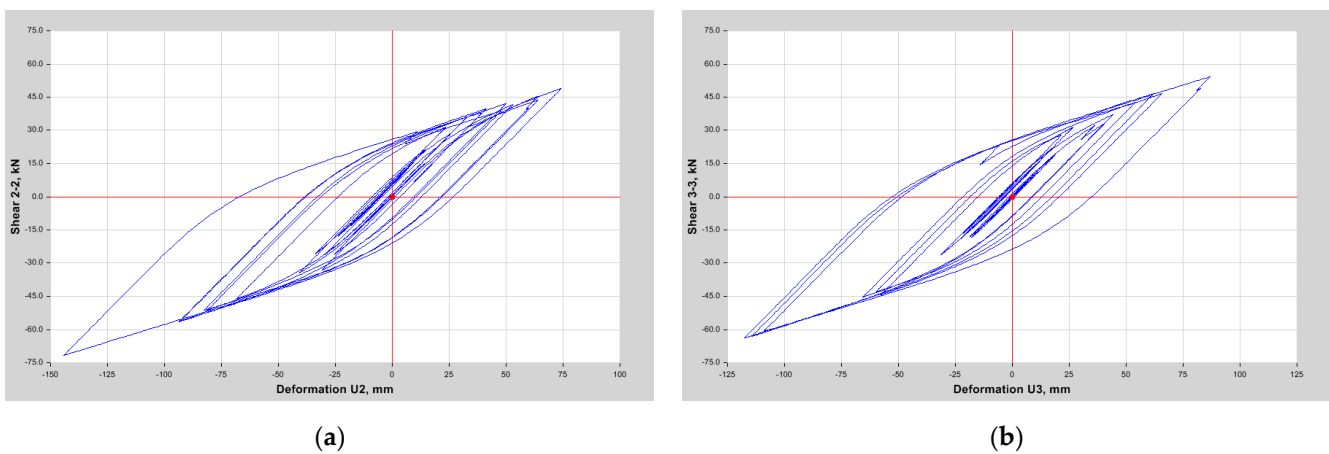

Figure 13. HDRB's hysteresis area (data from Dar El Beida seismic record): (a) in the X direction; (b) in the Y direction.

Fluid viscous dampers operate on the principle of energy dissipation through the flow of fluid through orifices. These dampers utilize the resistance generated by the fluid flow to dissipate energy and reduce the effects of seismic forces.

Figure 14 illustrates the characteristic hysteresis loops in the behavioral law of fluid viscous dampers. These loops represent the relationship between the applied force and the resulting displacement during oscillating cycles. The large hysteresis loops indicate the significant energy dissipation capability of the dampers. As the structure oscillates due to seismic forces, the fluid within the damper flows through the orifices, creating resistance and absorbing a substantial amount of energy. This dissipation of energy helps to mitigate the damaging effects of earthquakes on the structure.

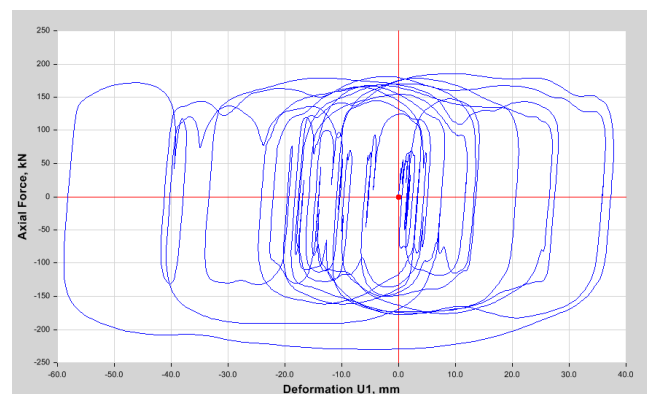

Figure 14. FVD's hysteresis loops (data from Dar El Beida seismic record).

The ability of fluid viscous dampers to dissipate energy and reduce the impact of seismic forces contributes to enhancing structural resilience and reducing potential damages during earthquake events.

5.3. Base Shear

Figure 15a,b and Figure 16a,b show a comparison of shear forces at the base for the three types of connection in both the X and Y directions. The below figures show a reduction in the shear force of the isolated structures compared to that of a fixed-base structure. Analyzing the specific data and values presented in the figures will provide a comprehensive understanding of the extent of shear force reduction achieved by the different isolation systems in both the X and Y directions.

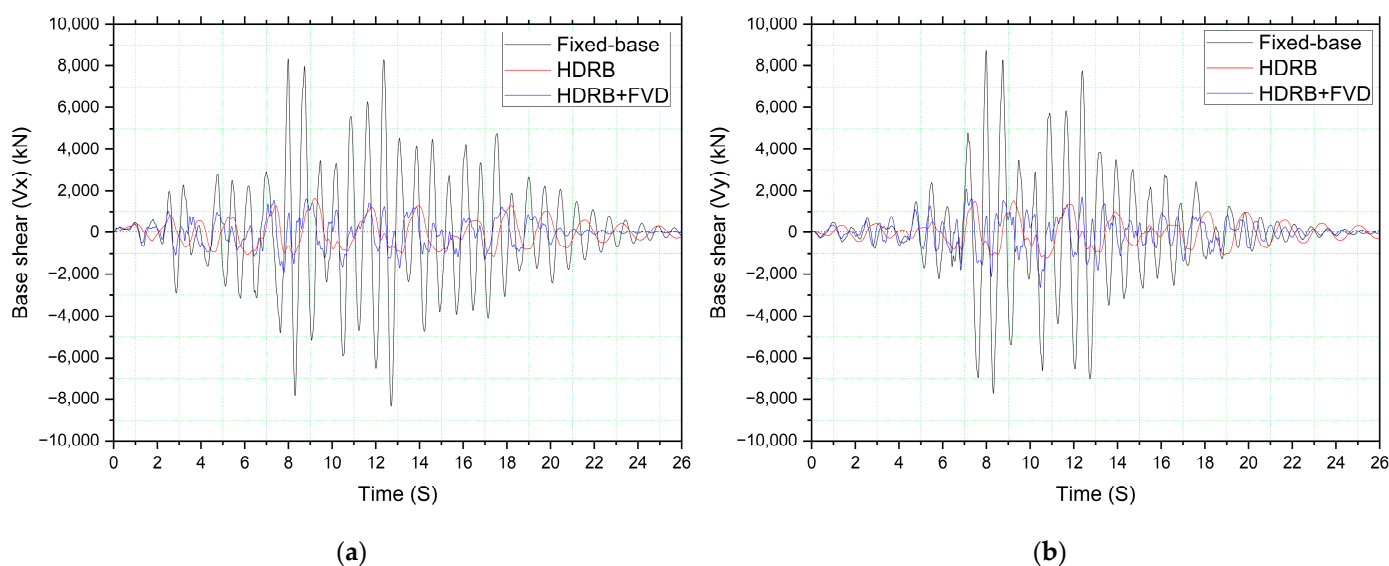

Figure 15. Base shear comparison for the three models (fixed-base, HDRB isolated, HDRB+FVD isolated) in Dar El-Beïda; (a) in the X direction; (b) in the Y direction.

Figure 17 illustrates the significant reduction in shear forces at the base for different isolation configurations in both the X and Y directions. In the X direction, the reduction is approximately 85 percent for an HDRB+FVD isolated structure compared to a fixed-base structure and around 78 percent for an HDRB isolated structure. This corresponds to a reduction of approximately 7 percent when comparing the two isolation systems.

Similarly, in the Y direction, the shear force reduction is approximately 86 percent for an HDRB + FVD isolated structure and 77 percent for an HDRB isolated structure, both in comparison to a fixed-base structure. This indicates a reduction of approximately 9 percent when comparing the two isolation systems.

These findings demonstrate that the shear forces at the base of the isolated structure are significantly lower compared to the fixed-base structure. The reduction in shear forces is attributed to the effective mitigation of transmitted accelerations to the superstructure through the implementation of isolation systems. The investigation confirms the effectiveness of the FVD system in reducing shear forces at the base.

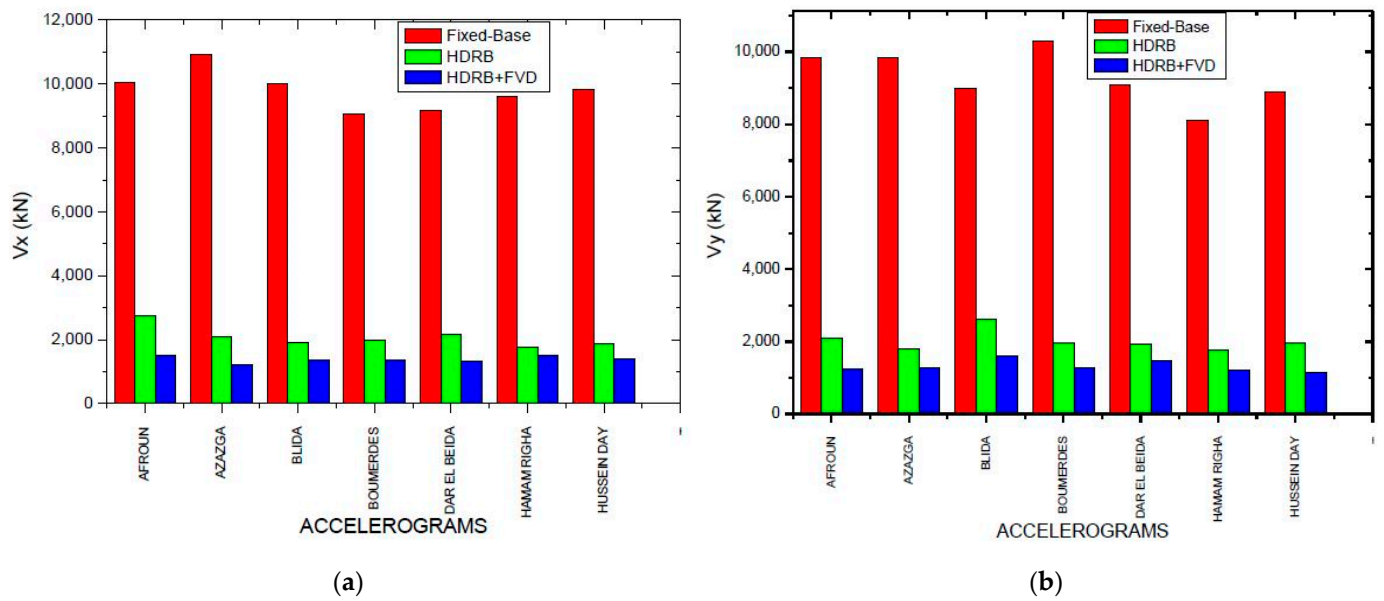

Figure 16. Base shear comparison for the three models (fixed-base, HDRB isolated, HDRB+FVD isolated) for different accelerograms; (a) in the X direction; (b) in the Y direction.

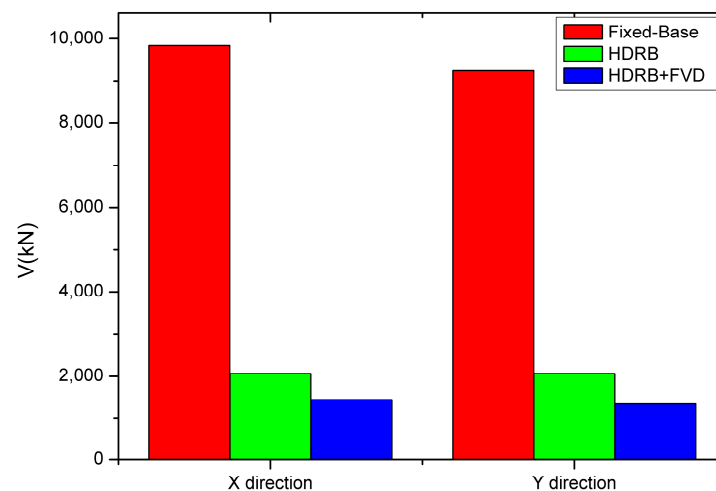

Figure 17. Average of base shear forces in the X and Y directions.

5.4. Displacement

Figures 18–20 compared the displacements for three types of isolation in both the X and Y directions. In comparison to a fixed base, the displacement of isolated structures increases in the figures below. It is important to note that while the displacements are higher in the isolated structures, this does not necessarily indicate poor performance or failure. The increase in displacements can be attributed to the enhanced flexibility introduced by the isolation systems; these allow for greater movement and deformation, which leads to higher displacements during seismic events.

From Figure 21, it can be seen that the maximum displacement in the X direction reduces by 46 percent in a structure isolated by HDRB and another isolated by HDRB+FVD. For the Y direction, the reduction is roughly 47 percent in the case of one HDRB and one HDRB+FVD isolated structure. The figure shows that the horizontal displacements induced in the isolated structures (HDRB) are greater than in the case of the fixed-base structure; this is explained by the fact that the isolation system (HDRB) is used without seismic dampers being used in conjunction with it. Seismic dampers are important to control the induced displacements in the superstructure; hence, the use of FVDs.

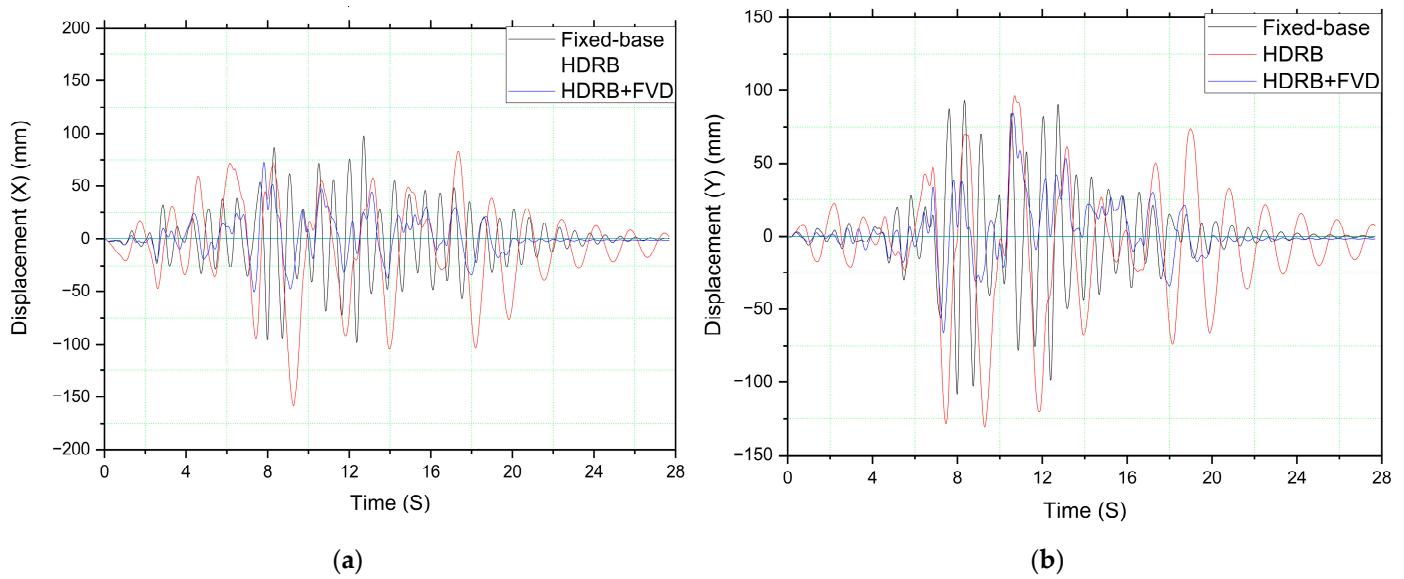

Figure 18. Displacement comparison for the three models (fixed-base, HDRB isolated, HDRB+FVD isolated) in Dar El-Beida; (a) in the X direction; (b) in the Y direction.

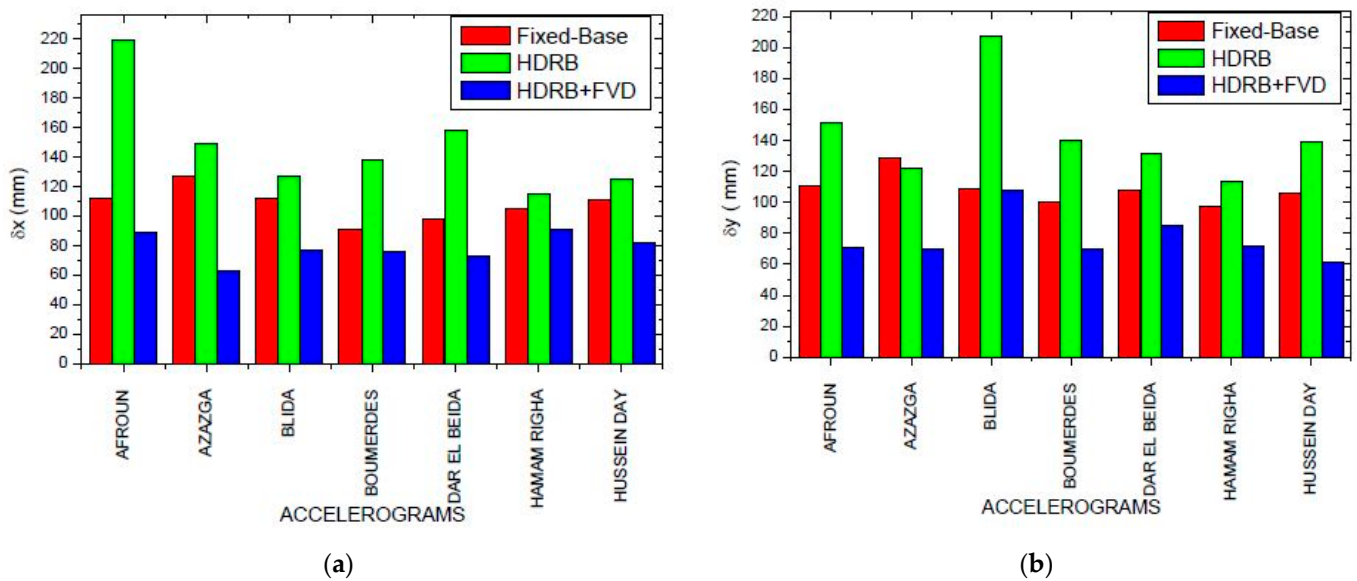

Figure 19. Displacement comparison for the three models (fixed-base, HDRB isolated, HDRB+FVD isolated) for different accelerograms; (a) in the X direction; (b) in the Y direction.

The evaluation of inter-story displacements, also known as drift, and their distribution throughout the height of the structure is crucial in assessing seismic performance, as it directly correlates to structural damage. Figure 22a,b depicts the inter-story displacements for the isolated and fixed-base structures.

In the case of the isolated structure represented by HDRB or HDRB + FVD isolation, the inter-story displacements are significantly reduced. The isolated structure behaves more rigidly, with minimal inter-story movement. On the other hand, the fixed-base structure exhibits substantial inter-story displacements, indicating a higher vulnerability to seismic forces.

When comparing the HDRB + FVD isolated structure to the fixed-base structure, a remarkable reduction of approximately 83 percent in inter-story displacements is observed. This reduction highlights the effectiveness of the isolation system in mitigating structural damage and limiting the extent of inter-story movement.

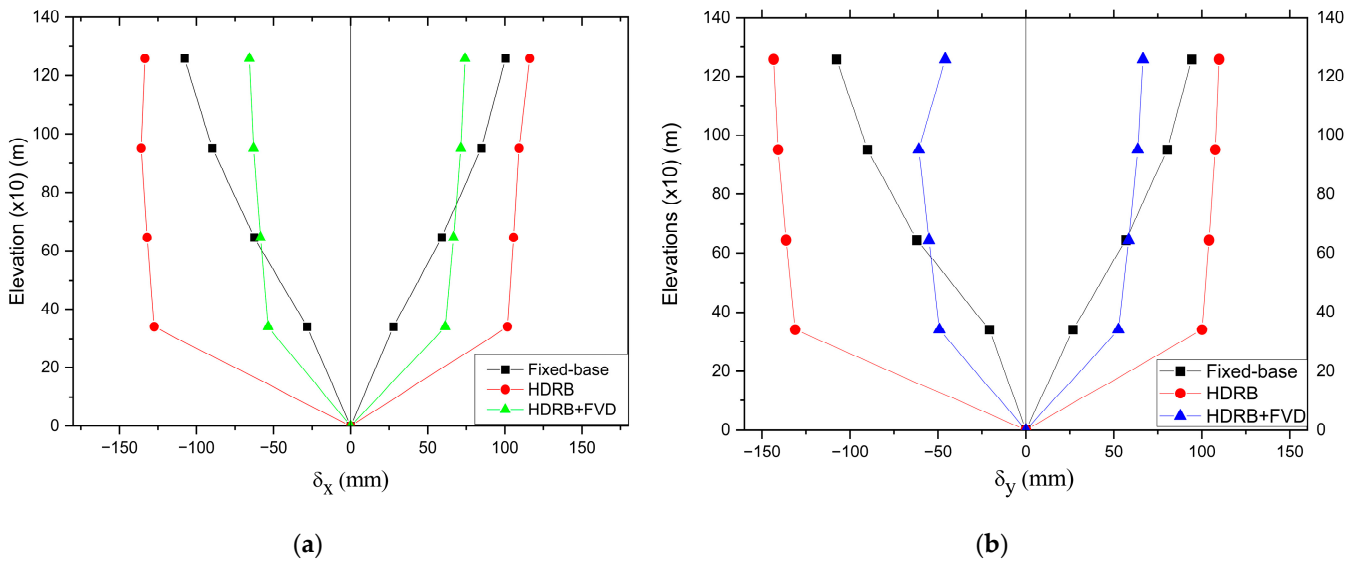

Figure 20. Average displacement for different levels; (a) in the X direction; (b) in the Y direction.

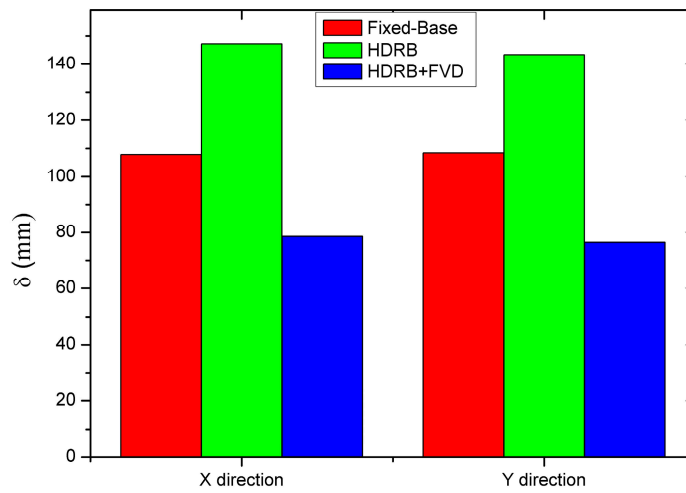

Figure 21. Average displacement at the top of the structure in the X and Y directions.

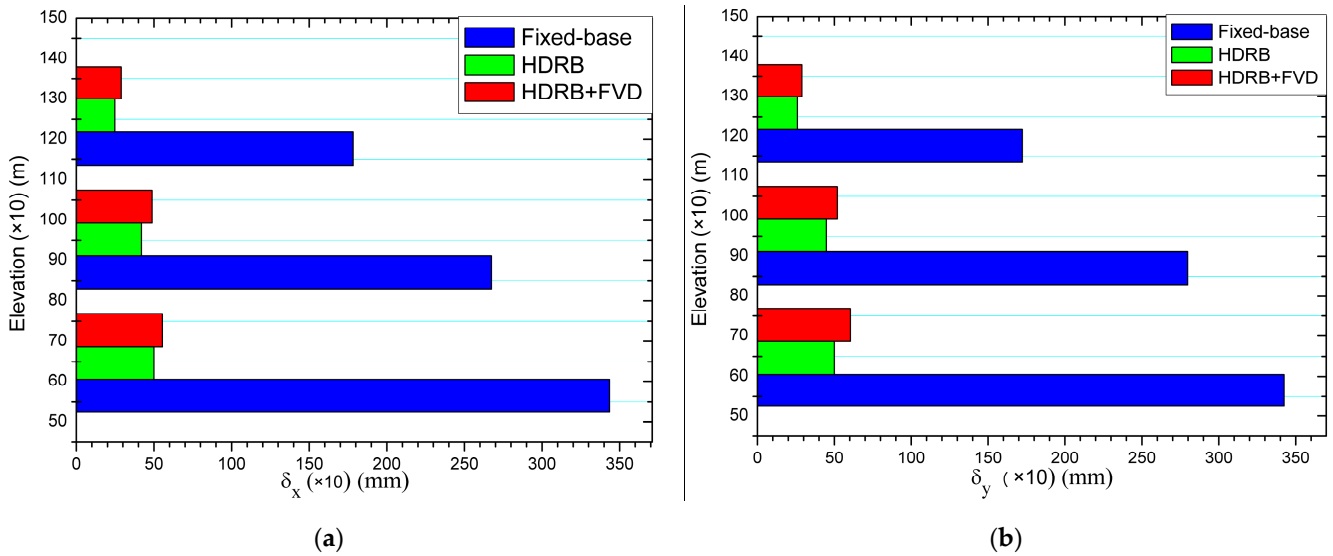

Figure 22. Drift comparison for the three models (fixed-base, HDRB isolated, HDRB + FVD isolated) for different levels; (a) in the X direction; (b) in the Y direction.

It is worth noting that controlling inter-story displacements is crucial for preserving the integrity and functionality of a structure during seismic events. By minimizing inter-story drift, the isolated structure can better withstand seismic forces and reduce the risk of damage or collapse.

5.5. Acceleration

Acceleration refers to the rate at which an object's velocity changes over time, and in the case of seismic events, it represents the shaking or ground motion experienced during an earthquake. Figure 23a,b compares the acceleration at the top of the structure for the three connections to the base in both the X and Y directions. The isolated structures' acceleration is lower than that of a fixed-base structure, as shown in the figures below, demonstrating the effectiveness of the isolation systems in reducing the seismic forces transmitted to the superstructure.

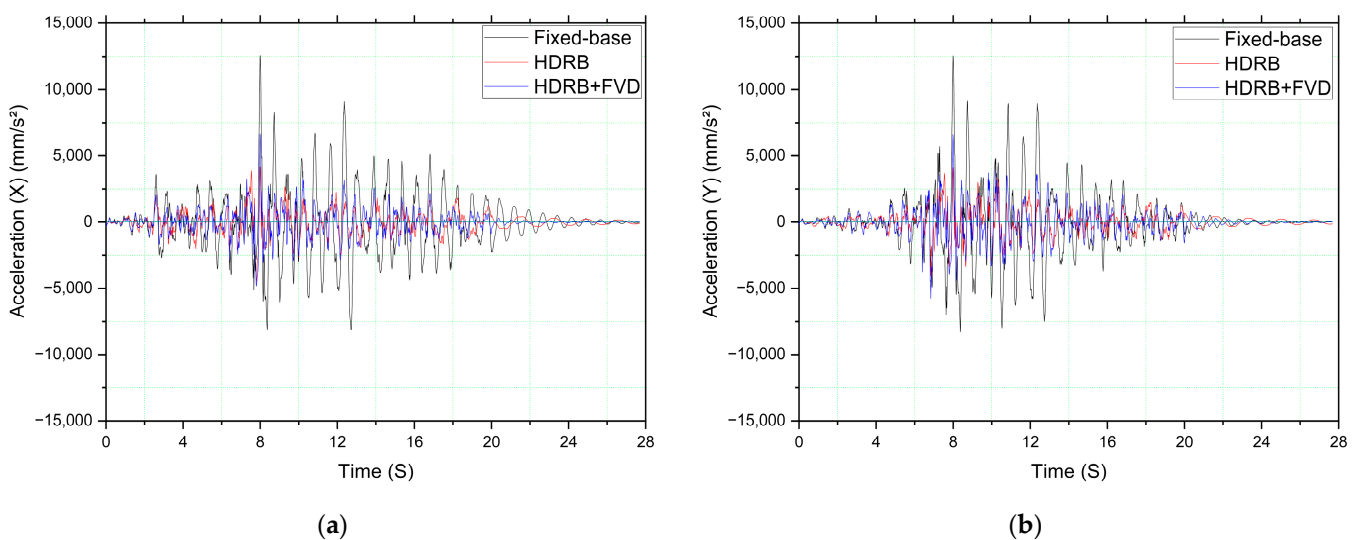

Figure 23. Acceleration comparison for the three models (fixed-base, HDRB isolated, HDRB+FVD isolated) in Dar El-Beïda; (a) in the X direction; (b) in the Y direction.

Figure 24a shows that the maximum recorded accelerations in the X direction are reported as 10.97 m/s^2 and 5.10 m/s^2 for the fixed-base and HDRB+FVD isolated structures, respectively. This indicates a significant reduction in acceleration of 54 percent for the HDRB+FVD isolated system compared to the fixed-base structure. Similarly, Figure 24b displays the highest measured accelerations in the Y direction, with the values of 10.92 m/s^2 for the fixed-base structure and 5.35 m/s^2 for the HDRB+FVD isolated structure. This demonstrates a 51 percent reduction in accelerations for the HDRB+FVD isolated system in comparison to the fixed-base system.

The results highlight the efficacy of the HDRB+FVD isolation system in reducing the structural acceleration response during seismic events. Through a substantial decrease in structural accelerations, the isolation system enhances occupant safety and minimizes the risk of structural damage.

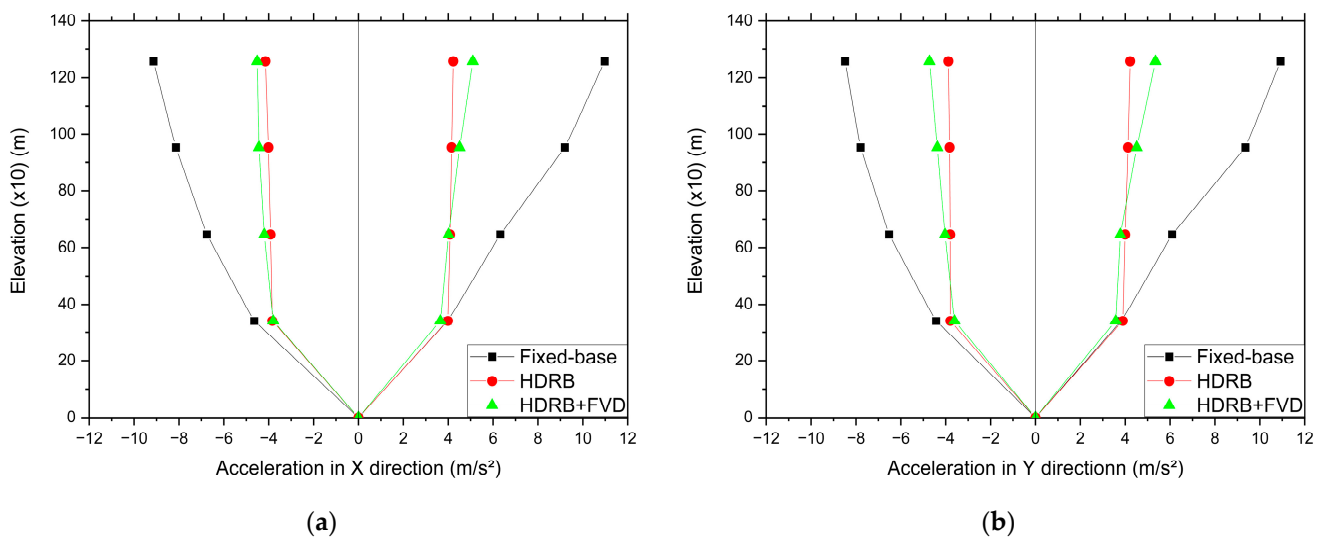

Figure 24. Acceleration comparison for the three models (fixed-base, HDRB isolated, HDRB+FVD isolated) for different levels; (a) in the X direction; (b) in the Y direction.

6. Conclusions

A numerical procedure for predicting the seismic behavior of isolated concrete structures has been proposed in this study. For the isolated structures, two different devices have been used in parallel, high-damping rubber bearings (HDRBs) and fluid viscous dampers (FVDs). They were simulated with ETABS v16 software, and the dynamic results were obtained by using multiple artificial accelerograms for Algeria using SeismoSoft v21 software.

The main findings of this work indicate significant advantages of using isolation systems for concrete structures. Firstly, isolated structures demonstrate prolonged periods compared to fixed-base structures, highlighting their increased flexibility and reduced vulnerability to seismic forces. The dynamic response of isolated structures is primarily governed by the first mode of vibration, emphasizing the dominant influence of the fundamental mode. Furthermore, the incorporation of high-damping rubber bearings (HDRBs) and fluid viscous dampers (FVDs) in the isolation system proves effective in mitigating shear forces. The shear forces measured at the base of a structure isolated by (HDRB + FVD) are lower by 7% than those at the base of an HDRB-isolated structure and by 85% than those in a fixed structure; this highlights the effectiveness of the isolation system in mitigating shear forces. Additionally, the isolated structures experience greater displacements compared to fixed-base structures. As a result, it is essential to pair supports with dampers to counteract these significant displacements and protect neighboring structures. On the other hand, inter-story displacements are negligible in isolated structures, underscoring the isolation system's capability to restrict movement within individual storeys. Finally, the accelerations experienced by the isolated structures are 54% lower than those of the fixed-base structure, contributing to a reduced sense of unease for residents during earthquakes.

Based on these findings, this study suggests several perspectives for further research:

- Development of new numerical methods incorporating different isolation systems and comparing them with existing models in the literature;
- Apply the present model to high-rise buildings and different accelerograms, especially in high seismicity areas;
- Validation of the numerical results through experimental studies to ensure their accuracy and reliability.

Finally, the authors hope that the results presented in this study will be useful in highlighting the contribution of FVDs to dissipating energy, with a view to improving the seismic response of buildings previously isolated by HDRBs.

Author Contributions: Conceptualization, A.B. (Asma Belbachir), A.B. (Abdelkader Benanane) and Z.S.M.L.; methodology, A.B. (Asma Belbachir), A.O., Z.R.H. and E.I.; software, A.B. (Asma Belbachir) and Z.S.M.L.; validation, A.B. (Abdelkader Benanane), M.H.-N. and S.A.; formal analysis, A.B. (Asma Belbachir) and A.O.; investigation, A.O., Z.R.H. and Z.S.M.L.; resources, Z.R.H., D.R. and E.I.; writing—original draft preparation, A.B. (Asma Belbachir), Z.R.H., D.R. and E.I.; writing—review and editing, M.H.-N. and S.A.; visualization, M.H.-N. and D.R.; supervision, A.B. (Abdelkader Benanane), A.O. and S.A.; project administration, A.B. (Abdelkader Benanane) and M.H.-N. All authors have read and agreed to the published version of the manuscript.

Funding: This research received no external funding.

Institutional Review Board Statement: Not applicable.

Informed Consent Statement: Not applicable.

Data Availability Statement: The data presented in this study are available on request from the corresponding author.

Conflicts of Interest: The authors declare no conflict of interest.

References

1. Furinghetti, M. Definition and Validation of Fast Design Procedures for Seismic Isolation Systems. *Vibration* **2022**, *5*, 290–305. [[CrossRef](#)]
2. Quaglini, V.; Pettorruso, C.; Bruschi, E. Design and Experimental Assessment of a Prestressed Lead Damper with Straight Shaft for Seismic Protection of Structures. *Geosciences* **2022**, *12*, 182. [[CrossRef](#)]
3. Freddi, F.; Ghosh, J.; Kotoky, N.; Raghunandan, M. Device Uncertainty Propagation in Low-Ductility RC Frames Retrofitted with BRBs for Seismic Risk Mitigation. *Earthq. Eng. Struct. Dyn.* **2021**, *50*, 2488–2509. [[CrossRef](#)]
4. Pall, A.S.; Verganelakis, V.; March, C. Friction-Dampers for seismic control of Concordia University Library Building. In Proceedings of the 5th Canadian Conference on Earthquake Engineering, Ottawa, ON, Canada, 6–8 July 1987; pp. 191–200.
5. Pasquin, C.; Leboeuf, N.; Pall, R.T.; Pall, A. Friction dampers for seismic rehabilitation of Eaton’s building, Montreal. In Proceedings of the 13th World Conference on Earthquake Engineering, Vancouver, BC, Canada, 1–6 August 2004; pp. 1–2.
6. Li, H.N.; Li, G.; Wang, S.Y. Study and application of metallic yielding energy dissipation devices in buildings. In Proceedings of the Tenth U.S. National Conference on Earthquake Engineering Frontiers of Earthquake Engineering, Anchorage, AK, USA, 21–25 July 2014.
7. Vaiana, N.; Sessa, S.; Marmo, F.; Rosati, L. An accurate and computationally efficient uniaxial phenomenological model for steel and fiber reinforced elastomeric bearings. *Compos. Struct.* **2019**, *211*, 196–212. [[CrossRef](#)]
8. De Domenico, D.; Losanno, D.; Vaiana, N. Experimental tests and numerical modeling of full-scale unbonded fiber reinforced elastomeric isolators (UFREIs) under bidirectional excitation. *Eng. Struct.* **2023**, *274*, 115118. [[CrossRef](#)]
9. Orfeo, A.; Tubaldi, E.; Losanno, D. Dynamic behaviour and seismic response of structures isolated with low shape factor bearings. *Earthq. Eng. Struct. Dyn.* **2023**, 1–23. [[CrossRef](#)]
10. Li, T.; Yang, Y.; Xu, J.; Dai, K.; Ge, Q.; Wang, J.; Chen, P.; Wang, B.; Huang, Z. Hysteretic behavior of high damping rubber bearings under multiaxial excitation. *Soil Dyn. Earthq. Eng.* **2022**, *163*, 107549. [[CrossRef](#)]
11. Li, T.; Yang, Y.; Dai, K.; Ge, Q.; Wang, J. Influence of ground motion duration on seismic performance of RC frame isolated by high damping rubber bearings. *Eng. Struct.* **2022**, *262*, 114398. [[CrossRef](#)]
12. Zhang, D.; Yu, Y.; Sun, K.; Shi, Y. On the Adaptability and Effect of High Damping Rubber Bearings in the Seismic Resistance of Large Aqueducts. *Adv. Mater. Sci. Eng.* **2023**, *2023*, 2269904. [[CrossRef](#)]
13. Li, Y.; Ma, Y.; Zhao, G.; Liu, R. Study on the Basic Performance Deterioration Law and the Application of Lead Rubber Bearings under the Alternation of Aging and Seawater Erosion. *Buildings* **2023**, *13*, 360. [[CrossRef](#)]
14. Shadiya, P.V.; Priyanka Dilip, P. Seismic Analysis of Irregular Buildings with And Without Lead Plug Rubber Bearings (LPRB). *J. Recent. Act. Infr. Sci.* **2023**, *8*, 1–11.
15. Chen, P.; Wang, B.; Zhang, Z.; Li, T.; Dai, K. A Generalized Model of Lead Rubber Bearing Considering Large Strain Stiffening and Degradation. *Eng. Struct.* **2023**, *275*, 115264. [[CrossRef](#)]
16. Deringöl, A.H.; Güneyisi, E.M. Enhancing the Seismic Performance of High-Rise Buildings with Lead Rubber Bearing Isolators. *Turkish J. of Eng.* **2023**, *7*, 99–107. [[CrossRef](#)]
17. Avinash, A.R.; Krishnamoorthy, A.; Kamath, K.; Chaithra, M. Sliding Isolation Systems: Historical Review, Modeling Techniques, and the Contemporary Trends. *Buildings* **2022**, *12*, 1997. [[CrossRef](#)]
18. Chen, X.; Xiong, J. Seismic resilient design with base isolation device using friction pendulum bearing and viscous damper. *Soil Dyn. Earthq. Eng.* **2022**, *153*, 107073. [[CrossRef](#)]
19. Chen, X.; Wu, P.; Li, C. Seismic performance assessment of base-isolated tall pier bridges using friction pendulum bearings achieving resilient design. *Structures* **2022**, *8*, 618–629. [[CrossRef](#)]

20. Tiong, P.L.Y.; Adnan, A.; Rahman, A.B.A.; Mirasa, A.K. Seismic base isolation of precast wall system using high damping rubber bearing. *Earthq. Struct.* **2014**, *7*, 1141–1169. [[CrossRef](#)]
21. Tiong, P.L.Y.; Kelly, J.M.; Or, T.T. Design approach of high damping rubber bearing for seismic isolation. *Smart Struct. Syst.* **2017**, *20*, 303–309. [[CrossRef](#)]
22. Islam, A.B.M.S.; Ahmad, S.I.; Al-Hussaini, T.M. Effect of Base Isolation on Buildings in Dhaka. In Proceedings of the 3rd International Earthquake Symposium, Dhaka, Bangladesh, 5–6 March 2010.
23. Islam, A.B.M.S.; Hussain, R.R.; Jameel, M.; Jumaat, M.Z. Non-linear time domain analysis of base isolated multi-storey building under site specific bi-directional seismic loading. *Autom. Constr.* **2012**, *22*, 554–566. [[CrossRef](#)]
24. Choiri, M.E.; Annisa, H.G. Design of Earthquake Resistant Building by Using Shear Wall and High Damping Rubber Bearing Base Isolator. In Proceedings of the 1st International Conference on Contemporary Risk Studies, South Jakarta, Indonesia, 31 March–1 April 2022.
25. Guler, E.; Alhan, C. Effectiveness of non-linear fluid viscous dampers in seismically isolated buildings. *Earthq Struct.* **2018**, *17*, 191–204. [[CrossRef](#)]
26. Karimi, M.R.B.; Genç, M.C. Effectiveness of FVD-BIS for protecting a base-isolated high-rise building against resonance. *Earthq Struct.* **2021**, *21*, 351–370. [[CrossRef](#)]
27. Tiwari, P.; Badal, P.; Suwal, R. Effectiveness of fluid viscous dampers in the seismic performance enhancement of RC buildings. *Asian J Civ. Eng.* **2023**, *24*, 309–318. [[CrossRef](#)]
28. Mokhtari, M.; Naderpour, H. Seismic vulnerability assessment of reinforced concrete buildings having nonlinear fluid viscous dampers. *Bull. Earthq. Eng.* **2022**, *20*, 7675–7704. [[CrossRef](#)]
29. Riaz, R.D.; Malik, U.J.; Shah, M.U.; Usman, M.; Najam, F.A. Enhancing Seismic Resilience of Existing Reinforced Concrete Building Using Non-Linear Viscous Dampers: A Comparative Study. *Actuators* **2023**, *12*, 175. [[CrossRef](#)]
30. De Domenico, D.; Ricciardi, G.; Takewaki, I. Design strategies of viscous dampers for seismic protection of building structures: A review. *Soil Dyn. Earthq. Eng.* **2019**, *118*, 144–165. [[CrossRef](#)]
31. Jaisee, S.; Yue, F.; Ooi, Y. A state-of-the-art review on passive friction dampers and their applications. *Eng. Struct.* **2021**, *235*, 112022. [[CrossRef](#)]
32. Armali, M.; Damerji, H.; Hallal, J.; Fakhri, M. Effectiveness of friction dampers on the seismic behavior of high rise building VS shear wall system. *Eng. Rep.* **2019**, *1*, e12075. [[CrossRef](#)]
33. Titirla, M.D. Using Friction-Yielding Damper CAR1 to Seismic Retrofit a Two-Story RC Building: Numerical Application. *Appl. Sci.* **2023**, *13*, 1527. [[CrossRef](#)]
34. Bustos, F.; Hinojosa, J.; Tuninetti, V. Computational Comparison of Performance of Different Steel Plate Shear Yielding Dampers. *Buildings* **2023**, *13*, 793. [[CrossRef](#)]
35. Shrikhande, D.; Joshi, G. Individual and Combined Effects of Lead Rubber Bearing and Fluid Viscous Damper Techniques on Seismic Response of Irregular Reinforced Concrete Buildings. *Intern. J. Constr. Eng. Plan.* **2022**, *8*, 17–28.
36. Yaktine, A.E.R.; Titirla, M.D.; Larbi, W. Effects of LRB isolators and Viscous dampers on seismic isolated irregular reinforced concrete buildings. In Proceedings of the Fourth International Conference on Acoustics and Vibration, Sousse, Tunisia, 19–21 December 2022.
37. Liu, Y.; Wu, J.; Donà, M. Effectiveness of fluid-viscous dampers for improved seismic performance of inter-storey isolated buildings. *Eng. Struct.* **2018**, *169*, 276–292. [[CrossRef](#)]
38. Khedmatgozar Dolati, S.S.; Mehrabi, A.; Khedmatgozar Dolati, S.S. Application of Viscous Damper and Laminated Rubber Bearing Pads for Bridges in Seismic Regions. *Metals* **2021**, *11*, 1666. [[CrossRef](#)]
39. Deringöl, A.H.; Güneş, E.M.; Hansu, O. Combined Effect of Bearing Stiffness of the Base Isolator and Damping Characteristics of the Viscous Damper on the Nonlinear Response of Buildings. *Int. J. Steel Struct.* **2022**, *22*, 1497–1517. [[CrossRef](#)]
40. Titirla, M.D. A State-of-the-Art Review of Passive Energy Dissipation Systems in Steel Braces. *Buildings* **2023**, *13*, 851. [[CrossRef](#)]
41. Roeder, C.W.; Stanton, J.F. Elastomeric Bearings: State-of-the-Art. *J. Struct. Eng.* **1983**, *109*, 2853–2871. [[CrossRef](#)]
42. RPA. *Algerian Seismic Regulations; 1999 Version 2003*; National Earthquake Engineering Center, CGS: Algiers, Algeria, 2003.
43. *MS EN 1998-1:2015*; Eurocode 8: Design of Structures for Earthquake Resistance—Part 1: General Rules, Seismic Actions and Rules for Buildings. European Committee for Standardization: Saint-Denis La Plaine, France, 2005.
44. Chen, Y.-J.; Guo, K.-M.; Li, Y.; Chen, F. Behavior of high damping seismic isolation rubber bearings for bridges. *J. Vib. Shock* **2015**, *34*, 136–140. [[CrossRef](#)]
45. Xue, S.-D.; Gao, J.-Y.; Jiang, C.-H.; Li, X.-Y. Experimental research on mechanical performance of high damping isolation rubber bearings. *Build. Struct.* **2020**, *50*, 71–75.
46. Dong, W.-W.; Ding, Y.-G.; Sun, H. Research on mechanical properties and restoring force model of high damping rubber bearing. *Eng. Constr.* **2020**, *52*, 6–11.
47. Wang, J.-W. *Research on Mechanical Performance and Stability Analysis of Thick Laminated Rubber Bearing*; Guangzhou University: Guangzhou, China, 2020.
48. Li, J.-C.; Shang, Q.-X.; Luo, Q.-Y.; Wang, T. Tests for mechanical performance of thick rubber bearings. *J. Vib. Shock* **2019**, *38*, 157–165.
49. Ghrewati, B.E.; Kurdi, K.E.T.; Jena, T. Developing local rubber mixture for seismic base isolation system type high damping rubber bearing. *Mater. Tod Proceed.* **2023**, *74*, 881–888. [[CrossRef](#)]

50. AASTHO. *LRFD Bridge Design Specifications*; American Association of State Highway and Transportation Officials: Washington DC, USA, 2010.
51. AASTHO. *Plain and Laminated Elastomeric Bridge Bearings*; American Association of State Highway and Transportation Officials: Washington, DC, USA, 2016.
52. CAN/CSA-S6-06; Canadian Highway Bridge Design Code. Canadian Standards Association (CSA): Ottawa, ON, Canada, 2010.
53. UBC. *Uniform Building Code: Structural Engineering Design Provisions*; International Conference of Building Officials: Whittier, CA, USA, 1997.
54. Naeim, F.; Kelly, J.M. *Design of Seismic Isolated Structures: From Theory to Practice*; John Wiley and Sons: New York, NY, USA, 1999. [[CrossRef](#)]
55. Markou, A.A.; Manolis, G.D. Mechanical formulations for bilinear and trilinear hysteretic models used in base isolators. *Bull. Earthq. Eng.* **2016**, *14*, 3591–3611. [[CrossRef](#)]
56. Vaiana, N.; Spizzuoco, M.; Serino, G. Wire rope isolators for seismically base-isolated lightweight structures: Experimental characterization and mathematical modelling. *Eng. Struct.* **2017**, *140*, 498–514. [[CrossRef](#)]
57. Vaiana, N.; Sessa, S.; Marmo, F.; Rosati, L. A class of uniaxial phenomenological models for simulating hysteretic phenomena in rate-independent mechanical systems and materials. *Nonlinear Dyn.* **2018**, *93*, 647–1669. [[CrossRef](#)]
58. *Computers and Structures, Structural Software ETABS*; CSI: Berkeley, CA, USA, 2016.
59. He, W.; Kang, J.; Yang, S.; Liu, W.; Liu, W. Experimental Research on the Seismic Characteristics of a Precast Frame Structure with a Viscous Damper. *J. Earthq. Eng.* **2023**, *27*, 959–980. [[CrossRef](#)]
60. Taylor Devices, Inc. The World Leader in Shock and Vibration Control. Available online: <https://www.taylordevices.com/base-isolation/> (accessed on 23 April 2023).
61. Canney, N.; Malatesta, A. *Viscous Damper Modeling Design Guide*; Taylor Devices, Inc., The World Leader in Shock and Vibration Control: North Tonawanda, NY, USA. Available online: <https://www.taylordevices.com/damper-manual/> (accessed on 22 July 2023).
62. National Earthquake Engineering Center, CGS, Algiers, Algeria. 2018. Available online: <http://www.cgs-dz.org/index.php/fr/> (accessed on 22 July 2023).
63. Seismosoft. A Computer Program for Generation of Artificial Accelerograms. Available online: <https://seismosoft.com/> (accessed on 23 May 2023).
64. Haido, J.H. Prediction of RC Multi-Story Construction Performance with a New Proposed Design Spectrum Approach. *Tikrit j. Eng. Sci.* **2015**, *22*, 52–68. [[CrossRef](#)]

Disclaimer/Publisher’s Note: The statements, opinions and data contained in all publications are solely those of the individual author(s) and contributor(s) and not of MDPI and/or the editor(s). MDPI and/or the editor(s) disclaim responsibility for any injury to people or property resulting from any ideas, methods, instructions or products referred to in the content.