

# The Use of Machine Learning Models in Estimating the Compressive Strength of Recycled Brick Aggregate Concrete

---

**Khademi, Atefehossadat; Behfarnia, Kiachehr; Kalman Šipoš, Tanja; Miličević, Ivana**

*Source / Izvornik:* **Computational Engineering and Physical Modeling, 2021, 4, 1 - 25**

**Journal article, Published version**

**Rad u časopisu, Objavljena verzija rada (izdavačev PDF)**

<https://doi.org/10.22115/cepm.2021.297016.1181>

*Permanent link / Trajna poveznica:* <https://um.nsk.hr/um:nbn:hr:133:293122>

*Rights / Prava:* [Attribution-ShareAlike 4.0 International/Imenovanje-Dijeli pod istim uvjetima 4.0 međunarodna](#)

*Download date / Datum preuzimanja:* **2025-03-29**



GRAĐEVINSKI I ARHITEKTONSKI FAKULTET OSIJEK  
Faculty of Civil Engineering and Architecture Osijek

*Repository / Repozitorij:*

[Repository GrAFOS - Repository of Faculty of Civil Engineering and Architecture Osijek](#)







Contents lists available at CEPM

Computational Engineering and Physical Modeling

Journal homepage: [www.jcepm.com](http://www.jcepm.com)

## The Use of Machine Learning Models in Estimating the Compressive Strength of Recycled Brick Aggregate Concrete

Atefehossadat Khademi<sup>1\*</sup>, Kiachehr Behfarnia<sup>2</sup>, Tanja Kalman Šipoš<sup>3</sup> , Ivana Miličević<sup>4</sup> 

1. Undergraduate Student, Department of Mechanical and Energy Engineering, Shahid Beheshti University, Tehran, Iran

2. Associate Professor, Department of Civil Engineering, Isfahan University of Technology, Isfahan, Iran

3. Department for Technical Mechanics, Faculty of Civil Engineering Osijek, J.J. Strossmayer University of Osijek, Vladimira Preloga 3, Osijek, Croatia

4. Department for Materials and Structures, Faculty of Civil Engineering Osijek, J.J. Strossmayer University of Osijek, Vladimira Preloga 3, Osijek, Croatia

Corresponding author: [atefehossadat.khademi@gmail.com](mailto:atefehossadat.khademi@gmail.com)

 <https://doi.org/10.22115/CEPM.2021.297016.1181>

### ARTICLE INFO

#### Article history:

Received: 27 July 2021

Revised: 13 September 2021

Accepted: 17 September 2021

#### Keywords:

Concrete;

Cement;

Compressive strength;

ANFIS;

Artificial neural network;

Regression.

### ABSTRACT

The focus of this study is to investigate the applicability of Adaptive Neuro-Fuzzy Inference System (ANFIS), Artificial Neural Network (ANN), and Multiple Linear Regression (MLR) in modeling the compressive strength of Recycled Brick Aggregate Concrete (RBAC). A comparative study on the application of the aforementioned models is developed based on statistical tools such as coefficient of determination, mean absolute error, root mean squared error, and some others, and the application potential of each of these models is investigated. To study the effects of RBAC factors on the performance of representative data-driven models, the Sensitivity Analysis (SA) method is used. The findings revealed that ANN with  $R^2$  value of 0.9102 has a great application potential in predicting the compressive strength of concrete. In the absence of ANN, ANFIS with  $R^2$  value of 0.8538 is also an excellent substitute for predictions. MLR was shown to be less effective than the preceding models and is only recommended for preliminary estimations. In addition, Subsequent sensitivity analysis on the database indicates the reliability of the prediction models have a strong correlation to the number of input parameters. The application of ANN and ANFIS as a precursor to traditional methods can eliminate the need for old-style tests, thus, constituting a significant reduction in time and expense needed for design and/or repairs.

How to cite this article: Khademi, A., Behfarnia, K., Kalman Šipoš, T., Miličević, I. The use of machine learning models in estimating the compressive strength of recycled brick aggregate concrete. *Comput Eng Phys Model* 2021;4(4):01–25. <https://doi.org/10.22115/cepm.2021.297016.1181>



### Nomenclature

Adaptive Neuro-Fuzzy Inference System	<b>ANFIS</b>
Artificial Neural Network	<b>ANN</b>
Multiple Linear Regression	<b>MLR</b>
Recycled Brick Aggregate Concrete	<b>RBAC</b>
Sensitivity Analysis	<b>SA</b>
Recycled Aggregate Concrete	<b>RAC</b>
Coefficient of Determination	<b>R<sup>2</sup></b>
Nash-Sutcliffe Efficiency	<b>NSE</b>
Mean Absolute Error	<b>MAE</b>
Mean Absolute Percentage Error	<b>MAPE</b>
Root Mean Squared Error	<b>RMSE</b>
Fine Clay Tile	<b>FCT</b>
Coarse Clay Tile	<b>CCT</b>
Fine Clay Brick	<b>FCB</b>
Coarse Clay Brick	<b>CCB</b>
Fine Natural Aggregate	<b>FNA</b>
Coarse Natural Aggregate	<b>CNA</b>

## 1. Introduction

One of the issues the civil engineering industry is facing nowadays is the use of great amount of unsustainable materials in construction projects. Concrete is the most widely used material in civil engineering projects, and the use of recycled materials in it as a parameter of mix design can significantly reduce the amount of unsustainability in this industry. Crushed clay bricks and clay roof tiles are impressively valued, since they are environmentally friendly and can be used as an alternative to natural aggregates in the concrete mix design of concrete [1]. Subsequently, RBAC is an innovative, sustainable, and notable material with advanced properties that invites scientists to more explorations.

In order to find out the application scopes of recycled materials on mechanical properties of concrete, several scientists in the field have conducted quite a few studies. Debib and Kenai 2008 [1] have outlined that using coarse and fine crushed bricks would result in a 20% to 30% reduction in compressive strength of concrete, depending on the degree of substitution. Khademi et al. 2016 [2] have declared the usefulness of machine learning models in simulating the compressive strength of recycled aggregate concrete (RAC) constituting of 14 different dimensional and non-dimensional factors. The quality of concrete is directly related to the value of its compressive strength, and therefore, it is important to keep the compressive strength of concrete high up to some level. This has been the concept of research performed by Cachim 2009 [3], in which they have stated that using crushed bricks instead of natural aggregates up to 15%, would have no loss in compressive strength of concrete, and therefore, the concrete quality would be kept in good condition. They have also claimed that increasing the crushed bricks up to 30%, would result in a 20% reduction in the mechanical properties of concrete. Comparison of

compressive strength of RAC and normal aggregate concrete at early ages by different researchers [4–9] have shown that the RAC would have lower compressive strength compared to the other one. In other words, the performance of concrete generated with recycled aggregate is not as high quality as concrete produced with normal aggregate, stating by the fact that the water absorption of recycled aggregate is higher than the one to the normal gravel, which would directly affect the compressive strength of concrete. Poon and Chan 2007 [10] have compared the crushed brick aggregates and normal river aggregates in terms of the level of their grain hardness, and have declared that the concrete with the recycled brick aggregate has a lower compressive strength compared to the latter. It is worth noting that the concrete yet has adequate strength to respond to applied loads in different conditions, with the adjoined advantage of having lower density amounts, making it high standards where the self-weight is in the application. Poon and Chen 2007 [11] have also reported the existence of correlation between the amount of crushed brick aggregate, and the compressive strength and modulus of elasticity of concrete. They have stated that usage of 20% of fine crushed brick aggregate would result in reduction of 18% in the values of compressive strength and modulus of elasticity. In accordance with the aforesaid, overall use of recycled aggregate, more specifically crushed brick aggregates in concrete, as a parameter of mix design, would diminish the compressive strength of concrete. On the other hand, these type of recycled mixtures could still be efficient in certain applications, due to their lower density compared to concrete with normal mixtures. The relationship between the compressive strength of concrete and its mix design parameters cannot be expressed through one unique mathematical formula, and there is a need for more advanced optimization models to do so.

The application of machine learning models for predicting civil engineering variables is broadly gaining popularity, because of their capability to express complex non-linear correlations. Sadrilmomtazi et al. 2013 [12] have efficiently used the application of ANN and ANFIS models in predicting the strength of EPS lightweight concrete. Yuan et al. 2014 [13] have efficaciously estimated the compressive strength of concrete by developing genetic based algorithm and ANFIS models. In addition, Khademi et. al. [14] have performed research on concrete properties, and have fruitfully determined its 28 days compressive strength using ANN and ANFIS models. Ahmadi-Nedushan 2012 [15] have used the application of both ANFIS and optimal nonlinear regression models in determining the elastic modulus of normal and high strength concrete. However, there are only few studies available with the focus on the application of machine learning models in predicting the compressive strength of recycled aggregate concrete. In the research performed by Topcu and Saridemir 2008 [16], the ANN technique was used to determine the compressive strength and splitting tensile strengths of recycled aggregate concrete containing silica fume. Duan et al. 2013 [17] have used novel materials like paper, wood, tiles, natural stones, clay bricks, soft soils, etc. in their mix design, and fruitfully estimated the compressive strength of recycled aggregate concrete. Predicting the compressive strength of concrete containing red ceramic and other recycled materials for all ages of 3, 7, 28, and 91 days is the scope of the study performed by Dantas et al. 2013 [18], in which the aim was successfully achieved using the ANN techniques. Swapnasarit et al. 2020 [19] have also successfully used adaptive neuro-fuzzy inference system to predict the FRP shear contribution for wrapped shear deficient RC beams. Naderpour et al. 2018 [20] have used the artificial neural network to predict

the shear resistance of concrete beams reinforced by FRP bars. Ahmadi et al. 2017 [21] have achieved a reliable modeling using ANN method for determining the compressive strength of circular steel-confined concrete.

## 2. Significance of the study

In keeping with the above-mentioned, the great need for predicting the compressive strength of recycled brick aggregate concrete using progressed machine learning techniques is taken into considerations. In this study, the potential application of different soft computing models, i.e., Adaptive Neuro Fuzzy Inference System (ANFIS), Artificial Neural Network (ANN), and Multiple Linear Regression (MLR) are inspected for determining the compressive strength of recycled brick aggregate concrete based on elements of mix design. A database gathered from 147 experimental tests of RBAC is processed by these data-driven models. The performance of each of these machine-learning techniques is investigated, and the effect of mixture elements is studied using the Sensitivity Analysis (SA) technique.

## 3. Experimental database

Although several studies have been performed on recycled aggregate concrete, scientists have not yet been able to find any specific mathematical procedures for determining the compressive strength of concrete [6]. Besides, traditional methods of evaluating the compressive strength of concrete are usually both time consuming and costly. This study seeks to identify any correlations between the mix design components and the compressive strength of RBAC using the collected experimental data.

The total of 147 data collected from different studies construct our database in this study, shown in Table 1.

**Table 1**  
RBAC Experimental Database List Used in This Study.

Author	Year Published	Number of Specimens	Type of Aggregate	Reference Number
Milicevic	2011	62	Crushed Brick and Tile	8
Debieb & Kenai	2008	12	Recycled Brick and Limestone	1
Khalaf & DeVenny	2004	9	Crushed Brick	4
Rühl & Atkinson	1999	2	Recycled Brick	5
Khatib	2005	5	Recycled Brick	7
Cachim	2009	10	Recycled Brick	3
Poon et all -I	2007	3	Recycled Brick and Tile	9
Poon et all -II	2007	4	Recycled Brick and Tile	17
Topçu & Canbaz	2007	18	Crushed Brick	18
Alibdo et all	2017	22	Crushed Clay Brick	19

Not all the samples have all the mix design parameters, and as a result, only the specimens having all the parameters are used for the purpose of this study. The database, including both the input and output parameters are shown in Table 2.

**Table 2**  
Database Used in This Study.

Sample Number	Sample Label	Input data								Output data
		Cement (kg)	W/C Ratio	recycled aggregate				Natural Aggregate		
				Clay Tile		Clay Brick		Fine	Coarse	
				Fine	Coarse	Fine	Coarse			
		CT 0-4 (%)	CT 4-16 (%)	CB 0-4 (%)	CB 4-16 (%)	NA 0-4 (%)	NA 4-16 (%)	Compressive Strength (MPa)		
1	1	400	0.5	0	0	0	25	100	75	10.95
2	2	400	0.5	0	0	50	25	50	75	23.5
3	3	400	0.5	0	50	0	25	100	25	8.7
4	4	400	0.5	0	50	50	25	50	25	16.6
5	5	400	0.5	50	0	0	25	50	75	22.4
6	6	400	0.5	50	0	50	25	0	75	16.84
7	7	400	0.5	50	50	0	25	50	25	18.8
8	8	400	0.5	50	50	50	25	0	25	9.6
9	9	300	0.5	25	25	0	0	75	75	15.5
10	10	300	0.5	25	25	0	50	75	25	15.27
11	11	300	0.5	25	25	50	0	25	75	20
12	12	300	0.5	25	25	50	50	25	25	10.84
13	13	500	0.5	25	25	0	0	75	75	54.5
14	14	500	0.5	25	25	0	50	75	25	28.4
15	15	500	0.5	25	25	50	0	25	75	45.2
16	16	500	0.5	25	25	50	50	25	25	25.4
17	17	400	0.4	25	0	25	0	50	100	61.75
18	18	400	0.4	25	0	25	50	50	50	23.07
19	19	400	0.4	25	50	25	0	50	50	23.32
20	20	400	0.4	25	50	25	50	50	0	14.83
21	21	400	0.6	25	0	25	0	50	100	26
22	22	400	0.6	25	0	25	50	50	50	21.13
23	23	400	0.6	25	50	25	0	50	50	27.53
24	24	400	0.6	25	50	25	50	50	0	16.74
25	25	300	0.4	0	25	25	25	75	50	46.43
26	26	300	0.4	50	25	25	25	25	50	21.33
27	27	300	0.6	0	25	25	25	75	50	17.25
28	28	300	0.6	50	25	25	25	25	50	13.05
29	29	500	0.4	0	25	25	25	75	50	41.33
30	30	500	0.4	50	25	25	25	25	50	46
31	31	500	0.6	0	25	25	25	75	50	43.75
32	32	500	0.6	50	25	25	25	25	50	33.15
33	33	400	0.5	0	25	25	0	75	75	9.97
34	34	400	0.5	0	25	25	50	75	25	24.43
35	35	400	0.5	50	25	25	0	25	75	34.8
36	36	400	0.5	50	25	25	50	25	25	42.24
37	37	400	0.5	0	25	25	0	75	75	37.6
38	38	400	0.5	0	25	25	50	75	25	22.4
39	39	400	0.5	50	25	25	0	25	75	32
40	40	400	0.5	50	25	25	50	25	25	16.82
41	41	300	0.5	25	0	25	25	50	75	21
42	42	300	0.5	25	50	25	25	50	25	23.97
43	43	300	0.5	25	0	25	25	50	75	18.04
44	44	300	0.5	25	50	25	25	50	25	9.04

45	45	500	0.5	25	0	25	25	50	75	29.8
46	46	500	0.5	25	50	25	25	50	25	26.13
47	47	500	0.5	25	0	25	25	50	75	32.13
48	48	500	0.5	25	50	25	25	50	25	40.3
49	49	400	0.4	25	25	0	25	75	50	43.8
50	50	400	0.4	25	25	50	25	25	50	44.8
51	51	400	0.4	25	25	0	25	75	50	33
52	52	400	0.4	25	25	50	25	25	50	15.34
53	53	400	0.6	25	25	0	25	75	50	20.65
54	54	400	0.6	25	25	50	25	25	50	25.16
55	55	400	0.6	25	25	0	25	75	50	47.75
56	56	400	0.6	25	25	50	25	25	50	27.97
57	57	400	0.5	25	25	25	25	50	50	19.28
58	58	400	0.5	25	25	25	25	50	50	28.05
59	59	400	0.5	25	25	25	25	50	50	20.7
60	60	400	0.5	25	25	25	25	50	50	23.08
61	61	400	0.5	25	25	25	25	50	50	22.53
62	62	400	0.5	25	25	25	25	50	50	26.15
63	C <sub>0/0</sub>	350	0.61	0	0	0	0	100	100	30.62
64	C <sub>0/25</sub>	350	0.69	0	0	25	0	75	100	28.21
65	C <sub>0/50</sub>	350	0.77	0	0	50	0	50	100	26.73
66	C <sub>0/75</sub>	350	0.85	0	0	75	0	25	100	25.82
67	C <sub>0/100</sub>	350	0.93	0	0	100	0	0	100	22.35
68	C <sub>50/50</sub>	350	0.75	0	0	50	50	50	50	21.51
69	C <sub>100/100</sub>	350	0.89	0	0	100	100	0	0	18.26
70	C <sub>100/100</sub> <sup>+</sup>	350	0.86	0	0	100	100	0	0	21.23
71	C <sub>75/25</sub>	350	0.66	0	0	25	75	75	25	21.25
72	C <sub>100/50</sub>	350	0.72	0	0	50	100	50	0	20.73
73	C <sub>25/75</sub>	350	0.85	0	0	75	25	25	75	23.13
74	C <sub>50/100</sub>	350	1.08	0	0	50	100	50	0	19.56
75	M1 G	350.35	0.55	0	0	0	0	100	100	45.7
76	M1 O	329.47	0.55	0	0	0	100	100	0	37.6
77	M1 O <sup>+</sup>	345.95	0.55	0	0	0	100	100	0	46.7
78	M2 G	498.64	0.4	0	0	0	0	100	100	66.8
79	M2 O	453.13	0.4	0	0	0	100	100	0	53.8
80	M2 O <sup>+</sup>	480.63	0.4	0	0	0	100	100	0	66.7
81	M3 G	418.55	0.43	0	0	0	0	100	100	42.7
82	M3 O	384.27	0.43	0	0	0	100	100	0	38.8
83	M3 O <sup>+</sup>	402.35	0.43	0	0	0	100	100	0	44.2
84	NZ	320	0.55	0	0	0	0	100	100	35.39
85	ZI	320	0.55	0	0	0	100	100	0	32.99
86	control	325	0.5	0	0	0	0	100	100	46.7
87	CB 25	319	0.5	0	0	25	0	75	100	39.2
88	CB 50	314	0.5	0	0	50	0	50	100	37.7
89	CB 75	307	0.5	0	0	75	0	25	100	36.1
90	CB 100	303	0.5	0	0	100	0	0	100	33.2
91	NN 45	400	0.45	0	0	0	0	100	100	36.2
92	NA 45	400	0.45	0	0	0	15	100	85	32.1
93	NB 45	400	0.45	0	0	0	15	100	85	38.5
94	AA 45	400	0.45	0	0	0	30	100	70	27.6
95	BB 45	400	0.45	0	0	0	30	100	70	32.3
96	NN 50	400	0.5	0	0	0	0	100	100	30.5
97	NA 50	400	0.5	0	0	0	15	100	85	29.4
98	NB 50	400	0.5	0	0	0	15	100	85	32.3
99	AA 50	400	0.5	0	0	0	30	100	70	24.5
100	BB 50	400	0.5	0	0	0	30	100	70	29
101	Mix 1	410	0.55	0	0	0	0	100	100	53.8
102	Mix 2	410	0.55	0	0	20	0	80	100	47.2

103	Mix 3	410	0.55	20	0	0	0	80	100	45.5
104	control	526.76	0.41	0	0	100	100	0	0	80.5
105	10 T	489.76	0.49	10	10	0	0	90	90	65.6
106	5T5B	491.49	0.49	5	5	5	5	90	90	62.4
107	4B4G2T	493.98	0.49	2	2	8	8	90	90	66.2
108	K300_0	300	0.63	0	0	0	0	100	100	21.63
109	K300_50	300	0.63	50	50	0	0	50	50	15
110	K300_100	300	0.63	100	100	0	0	0	0	14.23
111	K350_0	350	0.54	0	0	0	0	100	100	27.15
112	K350_50	350	0.54	50	50	0	0	50	50	27.95
113	K350_100	350	0.54	100	100	0	0	0	0	19.81
114	K400_0	400	0.48	0	0	0	0	100	100	36.5
115	K400_50	400	0.48	50	50	0	0	50	50	30.12
116	K400_100	400	0.48	100	100	0	0	0	0	22.16
117	I300_0	300	0.63	0	0	0	0	100	100	26.32
118	I300_50	300	0.63	50	50	0	0	50	50	25.71
119	I300_100	300	0.63	100	100	0	0	0	0	15.13
120	I350_0	350	0.54	0	0	0	0	100	100	36.12
121	I350_50	350	0.54	50	50	0	0	50	50	27.36
122	I350_100	350	0.54	100	100	0	0	0	0	21.71
123	I400_0	400	0.48	0	0	0	0	100	100	36.23
124	I400_50	400	0.48	50	50	0	0	50	50	34.12
125	I400_100	400	0.48	100	100	0	0	0	0	31.65
126	I_1	350	0.5	0	0	0	0	100	100	33.6
127	I_2	350	0.5	0	0	25	0	75	100	36.5
128	I_3	350	0.5	0	0	50	0	50	100	34.6
129	I_4	350	0.5	0	0	75	0	25	100	32.1
130	I_5	350	0.5	0	0	100	0	0	100	27.6
131	I_6	350	0.5	0	0	0	25	100	75	34.2
132	I_7	350	0.5	0	0	0	50	100	50	33.6
133	I_8	350	0.5	0	0	0	75	100	25	25.8
134	I_9	350	0.5	0	0	0	100	100	0	22.3
135	I_10	350	0.5	0	0	50	50	50	50	29.6
136	I_11	350	0.5	0	0	100	100	0	0	23.8
137	II_14	250	0.7	0	0	0	0	100	100	22.5
138	II_15	250	0.7	0	0	25	0	75	100	23.4
139	II_16	250	0.7	0	0	50	0	50	100	21.9
140	II_17	250	0.7	0	0	75	0	25	100	23.1
141	II_18	250	0.7	0	0	100	0	0	100	15.9
142	II_19	250	0.7	0	0	0	25	100	75	22.3
143	II_20	250	0.7	0	0	0	50	100	50	22.1
144	II_21	250	0.7	0	0	0	75	100	25	18.6
145	II_22	250	0.7	0	0	0	100	100	0	16.2
146	II_23	250	0.7	0	0	50	50	50	50	22.3
147	II_24	250	0.7	0	0	100	100	0	0	15.5

The following eight (8) mix design parameters were selected as input variables in this study: (1) Cement, (2) W/C, (3) Fine clay tile, (4) Coarse clay tile, (5) Fine clay brick, (6) Coarse clay brick, (7) Fine natural Aggregate, and (8) Coarse natural aggregate. Furthermore, 28 days compressive strength of concrete is selected as the output variable in this investigation. It is worth mentioning that the aggregate partition was divided into two categorizations of fine and coarse aggregate. The fine aggregate included the aggregates between 0 to 4 mm, and the coarse aggregate included the ones between 4 to 16 mm. The characteristics of input and output elements are more clearly shown in Table 3.



**Table 3**  
Range of Input and Output Parameters.

Type	Element	Minimum Value	Maximum Value	Average Value
Input	Cement (kg)	250	526.76	374.17
Input	W/C ratio	0.4	4.08	0.54
Input	CT 0–4 (%)	0	100	16.92
Input	CT 4–16 (%)	0	100	16.78
Input	CB 0–4 (%)	0	100	23.35
Input	CB 4–16 (%)	0	100	26.48
Input	NA 0–4 (%)	0	100	59.73
Input	NA 4–16 (%)	0	100	56.73
Output	Compressive Strength (MPa)	8.7	80.5	29.81

The coarse aggregate in sample construction of this study did not use any of the mix design water, due to the assumption that the coarse aggregate should be fully saturated, and as a result, these coarse aggregates were soaked in water for 24 hours prior to using them in the mix design procedure. On the other hand, fine brick aggregates could not be fully soaked in water, and therefore, higher water content was needed for mix designs containing these fine brick aggregates. All other scientists used the effective water/cement ratio expressed as the amount of available water to react with the cement in the mix design.

#### 4. Statistical performance measures

Five different statistical performance measures were used to determine the effectiveness and prediction accuracies of all the studied soft computing models: (1) Coefficient of Determination ( $R^2$ ), (2) Nash-Sutcliffe Efficiency (NSE), (3) Mean Absolute Error (MAE), (4) Root Mean Squared Error (RMSE), and (5) Mean Absolute Percentage Error (MAPE). The explanation and formula of each are explained below [22,23]:

The coefficient of determination ( $R^2$ ) is interpreted as the proportion of the variance in the dependent variable that is predictable from the independent variable, shown in Equation (1).

$$R^2 = \frac{[\sum_{i=1}^n (y_i - \bar{y})(\hat{y}_i - \bar{\hat{y}})]^2}{\sum_{i=1}^n (y_i - \bar{y})^2 \sum_{i=1}^n (\hat{y}_i - \bar{\hat{y}})^2} \quad (1)$$

The Nash-Sutcliffe Efficiency (NSE) corresponds to a perfect match of modeled discharge to the observed data, shown in Equation (2).

$$E = 1 - \frac{\sum_{i=1}^n (y_i - \hat{y}_i)^2}{\sum_{i=1}^n (y_i - \bar{y})^2} \quad (2)$$

The Mean Absolute Error (MAE), as the name illustrates, is simply the mean of the absolute errors. The absolute error is the absolute value of the difference between the estimated value and actual value, shown in Equation (3).

$$MAE = \frac{1}{N} \sum_{i=1}^N |y_i - \hat{y}_i| \quad (3)$$

The Root Mean Squared Error (RMSE), is a frequently used measure of the differences between sample and population values predicted by a model or an estimator and the values actually observed, shown in Equation (4).

$$RMSE = \sqrt{\frac{1}{N} \sum_{i=1}^N (y_i - \hat{y}_i)^2} \quad (4)$$

The Mean Absolute Percentage Error (MAPE) is one of the most frequently used measures of prediction accuracy, shown in Equation (5).

$$MAPE = \frac{1}{N} \sum_{i=1}^N \left| \frac{y_i - \hat{y}_i}{y_i} \right| \quad (5)$$

In all cases, “ $y_i$ ” is the experimental strength of “ $i^{\text{th}}$ ” specimen, “ $\bar{y}$ ” is the averaged experimental strength, “ $\hat{y}_i$ ” is the calculated compressive strength of “ $i^{\text{th}}$ ” th specimen, and “ $\bar{\hat{y}}$ ” is the averaged calculated compressive strength.

Lower values of MAE, RMSE, and MAPE, and higher values of  $R^2$  and NSE imply the better efficiency of the prediction models.

## 5. Data-driven models

Most of the soft computing models, also called estimation models (or estimators), comprise of three steps of training, validation (check) and test. However, some data-driven models, MLR, for instance, might exclude the validation step. The training stage helps the model learn from a set of training examples. Generally, the main purpose of training step is to help model generate outputs as close as possible to target values, which can be done only by minimizing the error function in this step. Validation, the step acting independently from the training set, is used to construct the model. Finally, the accuracy of the machine learning algorithm is evaluated using the test step. The data-driven models used in this study are Adaptive Neuro-Fuzzy Inference System (ANFIS), Artificial Neural Network (ANN), and Multiple Linear Regression (MLR), which their structure and performance are explained in details in the following.

### 5.1. Adaptive neuro-fuzzy inference system (ANFIS)

An Adaptive neuro-fuzzy inference system (ANFIS) is based on Takagi-Sugeno fuzzy inference system (FIS) and its initial application goes back to early 1190s [24,25]. This technique is famous for determining the nonlinear functions with the help of both neural networks and fuzzy logic methodologies. The resultant outcome of fuzzy model is purely the weighted average of each rule’s output.

The fuzzy reasoning mechanism of ANFIS model considering two fuzzy if-then rules for a first-order Sugeno fuzzy model is stated as [14,22]:

Rule 1: IF  $x$  is  $A_1$  and  $y$  is  $B_1$ , THEN  $f_1 = p_1x + q_1y + r_1$ .

Rule 2: IF  $x$  is  $A_2$  and  $y$  is  $B_2$ , THEN  $f_2 = p_2x + q_2y + r_2$ .

Where  $\{p_i, q_i, r_i\}$  are the parameters of the  $i$ th rule.  $A_i$  and  $B_i$  are the linguistic labels and are represented by fuzzy sets shown in Figure 1 [2,26].

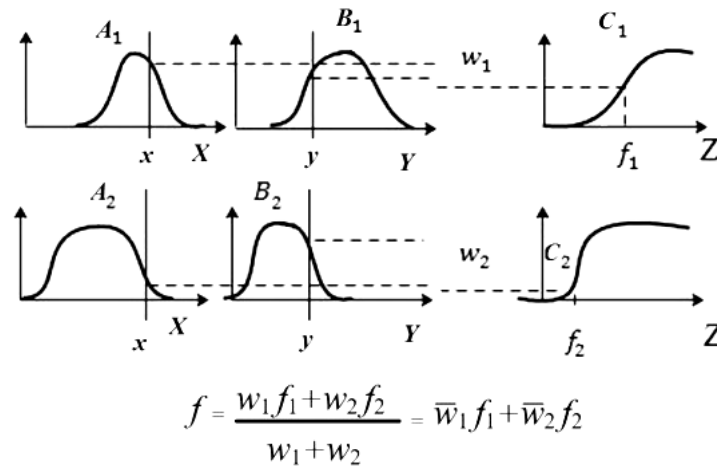

Fig. 1. The Sugeno Fuzzy Model.

The structure of ANFIS model consists of five layers, which behave differently from each other; yet, the nodes of the same layer act similarly. The architecture of ANFIS is shown in Figure 2.

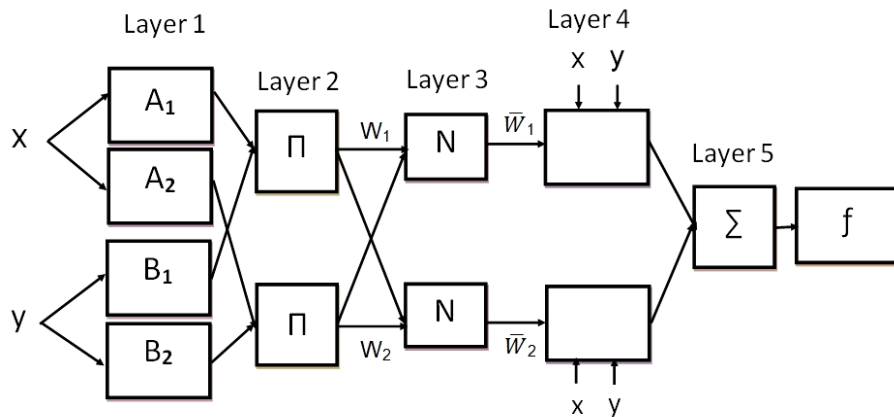

Fig. 2. Architecture of ANFIS Model.

These five (5) different layers are identified in the following [2,26]:

(1) Layer 1: This layer is entitled fuzzification layer. Using the help of membership function at any node  $i$  in this layer, it is transformed to membership values, demonstrated in Equation (6) [2,26]:

$$O_i^1 = \mu_{A_i}(x) \quad (6)$$

In which  $x$  is the input of node  $i$ , and  $A_i$  is the linguistic label linked to this node function.

(2) Layer 2: Any node in this layer multiplies the incoming signals and directs the outcomes out. In other words, each specific node existing in this layer is capable of determining the firing power of each rule. The example for this layer is shown in Equation (7) [2,26]:

$$w_i = \mu_{A_i}(y) \times \mu_{B_i}(y) , \quad i = 1,2 \tag{7}$$

(3) Layer 3: In order to normalize the membership values, this layer is the best place to do so.

The *i*th node in this layer calculates the ratio of the *i*th rule’s firing strength to the sum of all rule’s firing strength, shown in Equation (8) [2,26]:

$$\bar{w}_i = \frac{w_i}{(w_1+w_2)} , i = 1,2 \tag{8}$$

(4) Layer 4: In order to calculate the relationship between the input and output parameters, layer four, also called the adaptive layer, would be used. The related formula is shown in Equation (9) [2,26]:

$$O_i^4 = \bar{w}_i(p_i x + q_i y + r_i) \tag{9}$$

Where  $\bar{w}_i$  is the output resulted from layer 3, and  $\{p_i, q_i, r_i\}$  is the parameter set.

(5) Layer 5: This layer is also called the de-fuzzification layer. The signal node in this layer is a circle node labeled  $\Sigma$  that computed the overall output as the sum of all input signals shown in Equation (10) [2,26]:

$$O_i^5 = \sum_i \bar{w}_i f_i = \frac{\sum_i w_i f_i}{\sum_i w_i} \tag{10}$$

### 5.2. Artificial neural network (ANN)

In situations where simple estimators are not capable of solving the problems, the Artificial Neural Network is a good substitute to respond to those complex problems. The multi-layer backpropagation network is the most popular neural network paradigm which is repeatedly operated for well-organized generalization competence [27]. Artificial Neural Network is valued greatly, since it has the ability to be trained by examples, resulting this model to perform with great accuracy. Backpropagation neural networks normally is made of three layers of neurons, i.e.; (1) Input layer, (2) output layer, and (3) one or couple of hidden layers, shown in Figure (3) [6].

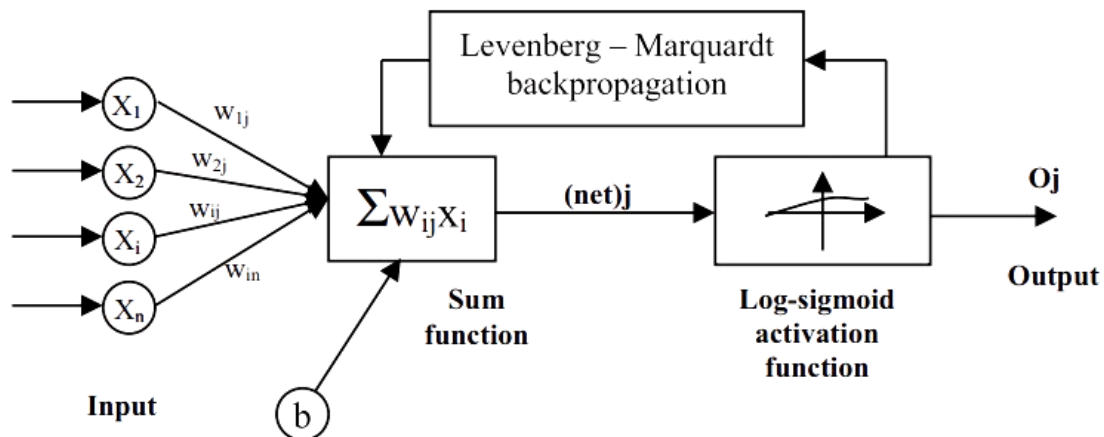

Fig. 3. Structure of Artificial Neural Network with 3 Layers.

The learning procedure is processed in the output layer, where the error between the network output values and desired outputs is determined, and next, propagated back to the network with updated weights. The whole training procedure is repeated up to the point where the network could get to its desired accuracy of the output values [28,29].

Mainly, ANN contains three stages of training, validation, and test; (1) In the training step the subset is trained and learned from examples, similar to what happens to human brains. The number of epochs is repeated, until the acknowledged accuracy of the model is reached, (2) The validation step would recognize how well the model is being trained, in addition to being capable of estimating other properties of the model, such as mean error for numerical predictors, classification errors, etc., and (3) The test step would be capable of verification of the performance of the constructed training subset [14].

Selecting the paramount number of hidden neurons significantly influences the accuracy of the final results, and might either cause overfitting or under-fitting of the estimation models. Specifically, the number of hidden neurons influences the stability of the ANN model strongly, i.e., choosing plenty of number of hidden neurons will lead to overfitting where ANN overestimates the complexity of the target problem, and vice versa. Accordingly, for a model to have steady generalization with the lowest possible prediction deviation, choosing proper number of hidden neurons greatly matters. As a result, researchers have proposed various empirical formulas for estimating the most optimal number of hidden neurons, some of which are shown in Table 4.

**Table 4**

Empirical Formulas for Determining Number of Hidden Neurons ( $N_H$ ).

Number	Name of First Author	$N_H$	Year Published	Reference
1	Behfarnia	$2N_i + 1$	2017	25
2	Nikoo	$2N_i + 1$	2015	26
3	Sadowski	$2N_i + 1$	2017	27
4	Sheela	$(4N_i^2 + 3)(N_i^2 - 8)$	2013	28
5	Li	$(\sqrt{1 + 8n} - 1)/2$	1995	29
6	Tamura	$N - 1$	1997	30
7	Fujita	$K \log \ P_c Z\  \log S$	1998	31
8	Hunter	$2^n - 1$	2012	32
9	Ke	$(N_{in} + \sqrt{N_p})/L$	2008	33
10	Zhang	$2^n / n + 1$	2003	34
11	Shibata	$\sqrt{N_i N_0}$	2009	35

$N_i$  = Number of input neurons,  $N_0$  = Number of output neurons

In this study, all the aforementioned formulas were examined to find the most efficient formula for determining the number of hidden nodes in the hidden layer, and among all of them,  $(2N_i+1)$

has been selected as the most practical one. Therefore, based on this formula, the number of hidden neurons in hidden layer of ANN model were determined as 17. In addition, in this research, eight (8) different parameters were selected as input variables which are: Cement, W/C, Fine clay tile, Coarse clay tile, Fine clay brick, Coarse clay brick, Fine natural Aggregate, Coarse natural aggregate. Also, the compressive strength of concrete is selected as the output variable, shown in Figure 4.

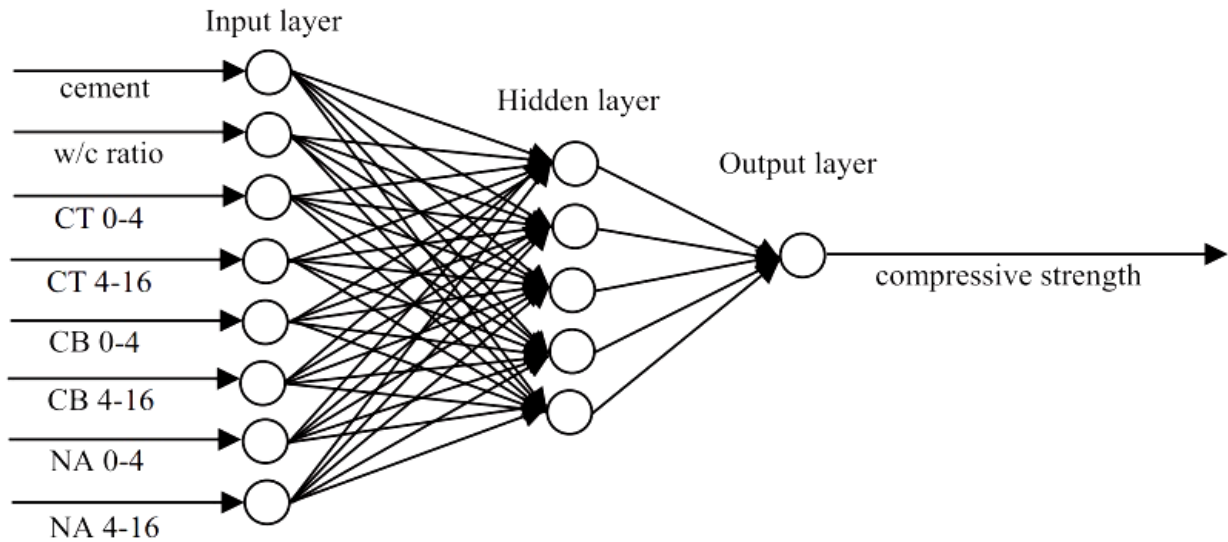

**Fig. 4.** Structure of Artificial Neural Network, consisting of 8 input parameters, one output parameter, one input layer, one hidden layer, and one output layer.

### 5.3. Multiple linear regression (MLR)

Normally, regression models can be defined as the process of fitting models to data. “Linear Regression” is the term used for those models which their estimator functions are performing linearly. Additionally, “Multiple Linear Regression” is the term used for those models which two or more input variables are involved in the linear regression. In other words, in Multiple Linear Regression (MLR), the relationship between two or more input variables is evaluated by fitting a linear regression to observed data. The general form of a multiple linear regression model is given in Equation (11), shown below [2]:

$$\hat{Y} = a_0 + \sum_{j=1}^m a_j X_j \quad (11)$$

Where  $\hat{Y}$  is the model’s output,  $X_j$  ‘s are the independent input variables to the model, and  $a_0, a_1, a_2, \dots, a_m$  are partial regression coefficients.

The elements are trained in such a way that the resulting outputs of the training data-set and the model are as close as possible to each other. Respectively, just one optimization model would be employed in which the sum of the squares of the vertical deviations from each data point to the regression equation would be minimized. For instance, if a data point fully lays on the fitted line, it would result in the zero amount of the vertical deviation. The MLR is used in this research to find out the correlation between mix design parameters and compressive strength of concrete.

## 6. Efficiency comparison of estimation models

### 6.1. Adaptive neuro-fuzzy inference system (ANFIS)

For ANFIS modeling, out of total of 147 case studies, 103 cases (i.e. 75% of all) are selected for training step, 22 case studies (i.e. 15% of all) were selected for check step, and 22 case studies (i.e. 15% of all) were selected for test step, shown in Table 5.

**Table 5**

Distribution of Data into three subsets of Training, Check (Validation), and Test steps.

	Training	Check (Validation)	Test
Percent	75%	15%	15%
Amount	103	22	22

Matlab software is used for our ANFIS modeling purposes in this study [30]. To generate the FIS in Matlab, the Sub Clustering method has been used, the hybrid method has been selected as train FIS optimization method, and the number of epochs has been chosen as 20. Eight (8) parameters of Cement, W/C, Fine clay tile, Coarse clay tile, Fine clay brick, Coarse clay brick, Fine natural Aggregate, Coarse natural aggregate were selected as input variables, and compressive strength of concrete was selected as output variable. The structure of ANFIS in MATLAB software is as shown in Figure 5.

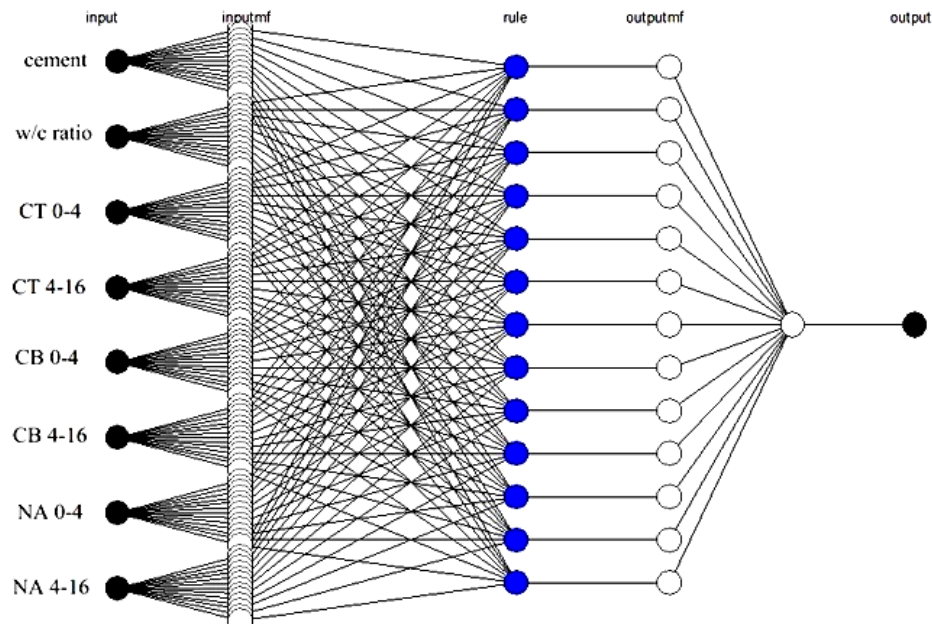

**Fig. 5.** Structure of ANFIS Model in Matlab Software.

Figure 6 shows the application of ANFIS modeling in Matlab for estimating the correlation between the measured and predicted values of compressive strength of concrete. According to the results, ANFIS with  $R^2$  value of 0.8538 is accepted to be a reliable model for estimating the compressive strength of concrete.

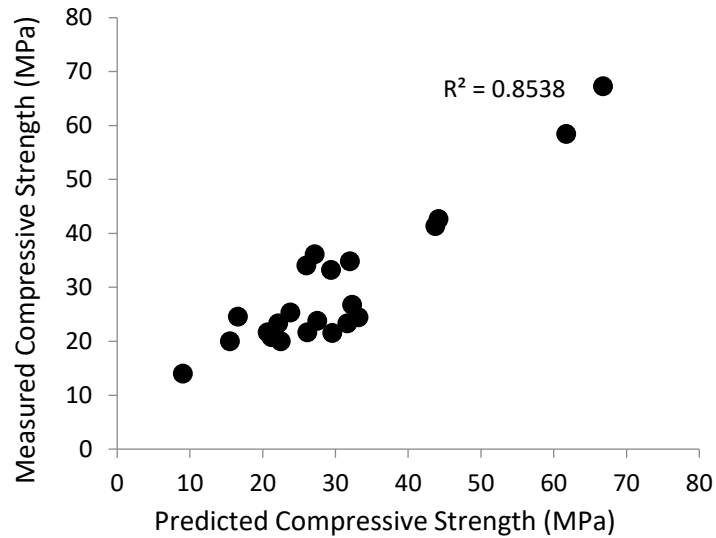

**Fig. 6.** Relationship between Measured and Predicted Compressive Strengths of RBAC using ANFIS Modeling.

The performance of ANFIS model in predicting the compressive strength of RBAC based on  $R^2$ , E, MAE, RMSE, and MAPE Values are as shown in Table 6.

**Table 6**  
 $R^2$ , E, MAE, RMSE, and MAPE Values of ANFIS Model.

	$R^2$	E	MAE	RMSE (Mpa)	MAPE (%)
<b>Value</b>	0.8538	0.8531	3.8438	5.1486	12.7678

According to Table 6, ANFIS model is a capable model for estimating the 28 days compressive strength of RBA concrete.

## 6.2. Artificial neural network (ANN)

### 6.2.1. Predicting the compressive strength of concrete using ANN

The ANN model in this study is comprised of eight (8) neurons in the input layer, and one neuron in the output layer. The number of nodes in the hidden layer, as discussed previously, is chosen as 17, to ensure good accuracy of the model. In order to guarantee a good generalization under ANN processing, it is necessary to divide the data set into three categorizations of training, validation, and test. Therefore, 75% of data (i.e. 103 specimens) were selected for training step, 15% of data (i.e. 22 specimens) were selected for validation step, and 15% of data (i.e. 22 specimens) were selected for test step. The characteristics of ANN modeling is shown in Table 7, and the structure of ANN modeling in MATLAB is as shown in Figure 7.



**Table 7**  
Characteristics of proposed ANN model in Matlab software.

Definition	Characteristic in ANN Model
Number of Input Variables	8
Number of Hidden Nodes in Hidden Layer	17
Number of Output Parameters	1
Number of Hidden Layers	1
Algorithm	Levenberg-Marquardt
Function for Hidden Nodes	Sigmoidal Tangent
Function for Output Layer	Linear Activation

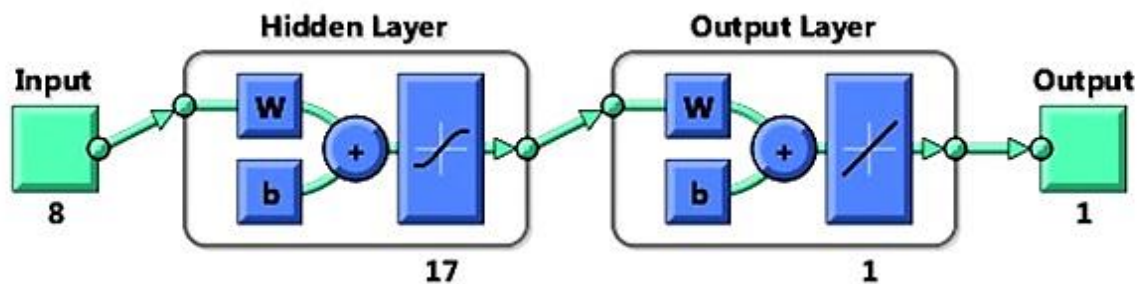

**Fig. 7.** Structure of ANN modeling in Matlab software with 8 input parameters, 17 hidden neurons in the hidden layer, one output variable, one hidden layer, and one output layer.

Figure 8 shows the correlation between measured and predicted compressive strength of studied specimens for the training step. According to this Figure, the training step of ANN model with  $R^2$  value of 0.9060 is accepted as a capable step in training the data set.

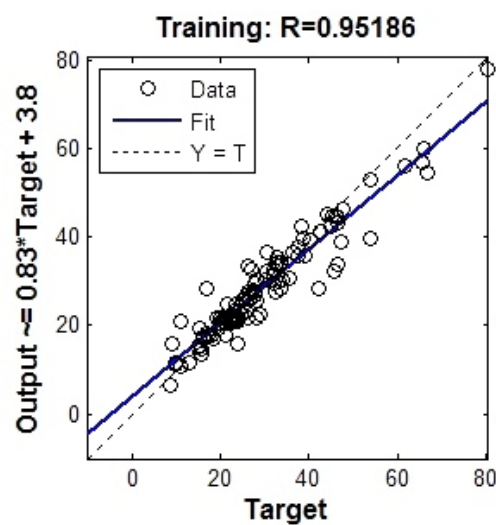

**Fig. 8.** Relationship between the Target and Output Values in the Training Step of ANN Model.

In addition, the relationship between the measured and predicted values of RBAC for test step is shown in Figure 9.

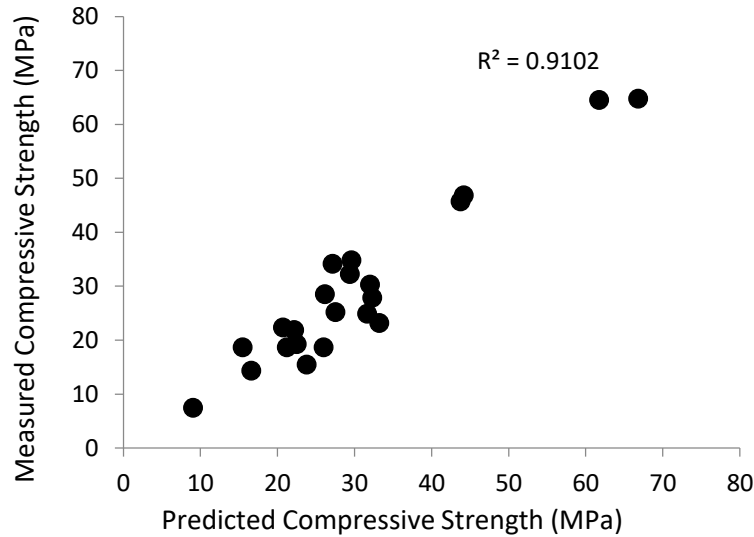

**Fig. 9.** Relationship between the Measured and Predicted Values of RBA concrete for Test Step of ANN Model.

Furthermore, the  $R^2$ , E, MAPE, RMSE, and MAE values of test step is shown in Table 8.

**Table 8**

$R^2$ , E, MAE, RMSE, and MAPE Values of ANN Model.

	$R^2$	E	MAE	RMSE (Mpa)	MAPE (%)
<b>Value</b>	0.9102	0.8874	1.0629	4.5067	4.5232

According to Table 8, ANN is a capable model in predicting the compressive strength of concrete. In addition, ANN with 17 hidden neurons is shown to be more capable than ANFIS model in estimating the compressive strength of RBAC.

### 6.2.2. Investigating the effect of number of hidden neurons on accuracy of the ANN model

As discussed earlier, choosing proper number of hidden neurons has direct impact on the prediction accuracy of the ANN model. In this study, different numbers of hidden neurons in the hidden layers are chosen and their influences on the accuracy of the model are investigated. The selected numbers of hidden neurons in the hidden layer are 5, 8, 12, 15, 17, 20, 24. The relationship between the target and output values of concrete in training step for all these various number of hidden neurons are shown in Figures 10 through 16.

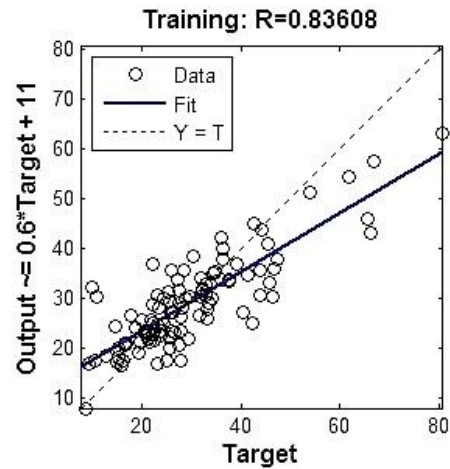

Fig. 10. Relationship between Target and Output Values in Training Step of ANN Modeling with 5 Hidden Neurons.

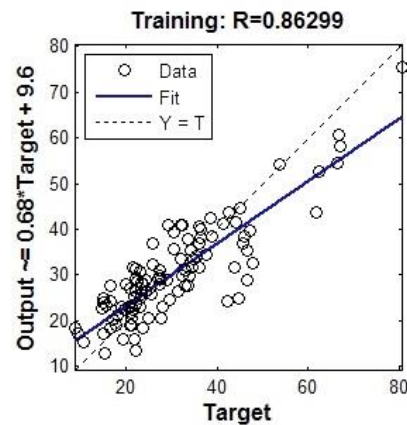

Fig. 11. Relationship between Target and Output Values in Training Step of ANN Modeling with 8 Hidden Neurons.

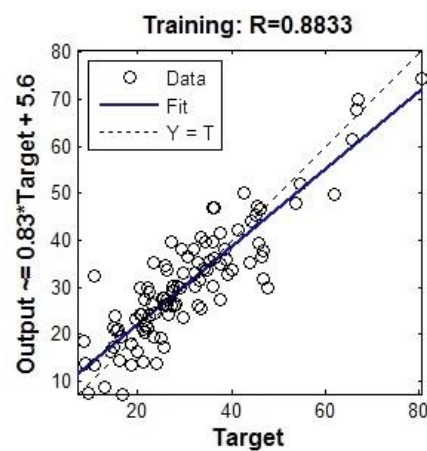
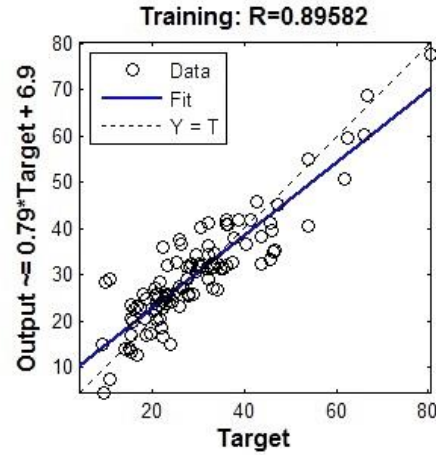
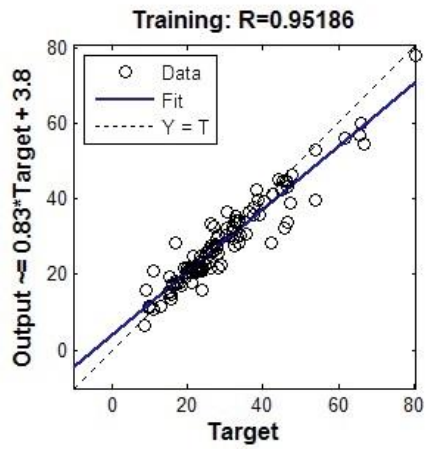

Fig. 12. Relationship between Target and Output Values in Training Step of ANN Modeling with 12 Hidden Neurons.



**Fig. 13.** Relationship between Target and Output Values in Training Step of ANN Modeling with 15 Hidden Neurons.



**Fig. 14.** Relationship between Target and Output Values in Training Step of ANN Modeling with 17 Hidden Neurons.

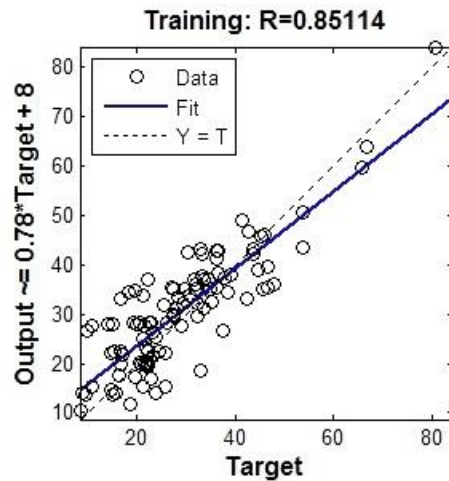

**Fig. 15.** Relationship between Target and Output Values in Training Step of ANN Modeling with 20 Hidden Neurons.

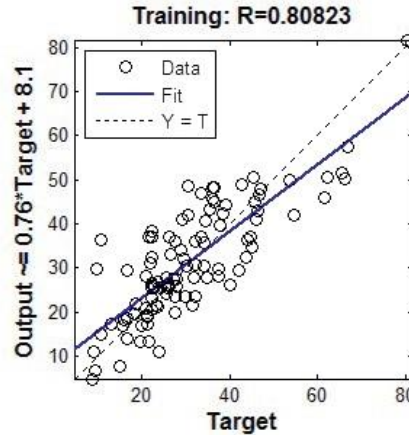

**Fig. 16.** Relationship between Target and Output Values in Training Step of ANN Modeling with 24 Hidden Neurons.

In addition, the R Values for both the training and test steps are shown in Table 9.

**Table 9**

R Values of Training and Test Steps for Various Number of Hidden Neurons.

Number of Hidden Neurons	R Value of Training Step	R Value of Test Step
5	0.83608	0.85043
8	0.86299	0.86451
12	0.88330	0.89236
15	0.89582	0.89785
17	0.95186	0.95404
20	0.85114	0.86443
24	0.80823	0.82762

According to Table 9, choosing 17 hidden neurons would result in having the best accuracy for both the training and test steps, and therefore, in order to approximate the number of hidden nodes in the hidden layer, the experimental formula of  $2N+1$  is shown to be a reliable and efficient equation.

### 6.3. Multiple linear regression (MLR)

In the MLR model, the data are divided into two groups of training and test. The proportions of training and test subsets are selected in consideration of the fact that the general structure of the model is built with respect to the training dataset. Subsequently, 85% of data (i.e. 125 specimens) were selected for training step, and 15% of data (i.e. 22 specimens) were selected for test step. Figure 17 shows the relationship between the measured and predicted compressive strength of concrete for MLR model for the test step.

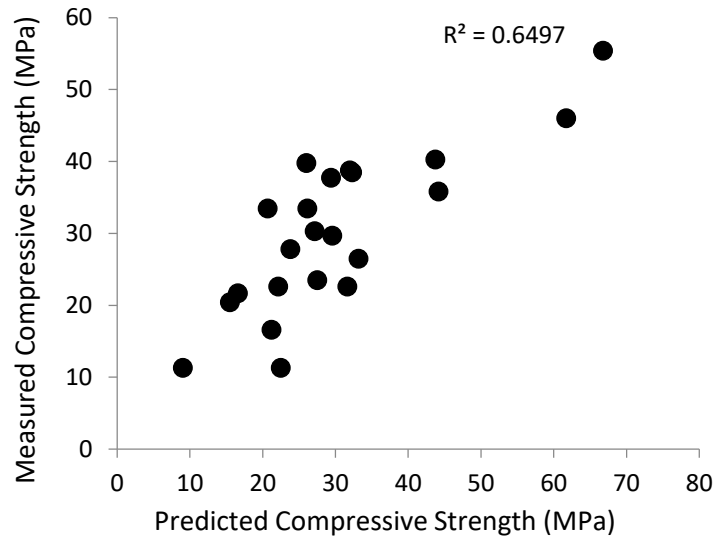

**Fig. 17.** Relationship between the measured and predicted compressive strength of concrete for MLR model for test step.

Furthermore, the  $R^2$ , E, MAPE, RMSE, and MAE values of test step is shown in Table 10.

**Table 10**

$R^2$ , E, MAE, RMSE, and MAPE Values of MLR Model.

	$R^2$	E	MAE	RMSE (Mpa)	MAPE (%)
<b>Value</b>	0.6497	0.6497	6.7995	7.9496	24.2315

According to the table, MLR model did not present an acceptable level of accuracy in estimating the compressive strength of RBAC. This might be due to the fact that MLR performs based on the linear functionality and it is not as powerful in nonlinear correlations. As a result, due to the nonlinear relationship of the RBAC parameters, MLR is not considered as a capable prediction model in this case.

#### 6.4. Sensitivity analysis (SA)

Sensitivity Analysis (SA) is defined as exploration of how much model output values are affected by the changes in the model input values. In this research, ANN and ANFIS model are used to perform the sensitivity analysis on dataset. The sensitivity analysis in this study is performed to explore the impact of number of input parameters on the output element. Different ANN and ANFIS Models have been constructed to study the effect of number of input parameters on the accuracy of the prediction models, shown in Table 11.

Figure 18 and Figure 19 show the coefficient of determinations ( $R^2$  values) for all the presented models of Table 11.

**Table 11**

Characteristics and number of input parameters for each modeled ANN and ANFIS models.

Input Parameters	Number of Input Parameters	ANN Model	ANFIS Model
Cement, W/C	2	ANN1	ANFIS1
Cement, W/C, FCT	3	ANN2	ANFIS2
Cement, W/C, FCT, CCT	4	ANN3	ANFIS3
Cement, W/C, FCT, CCT, FCB	5	ANN4	ANFIS4
Cement, W/C, FCT, CCT, FCB, CCB	6	ANN5	ANFIS5
Cement, W/C, FCT, CCT, FCB, CCB, FNA	7	ANN6	ANFIS6
Cement, W/C, FCT, CCT, FCB, CCB, FNA, CNA	8	ANN7	ANFIS7

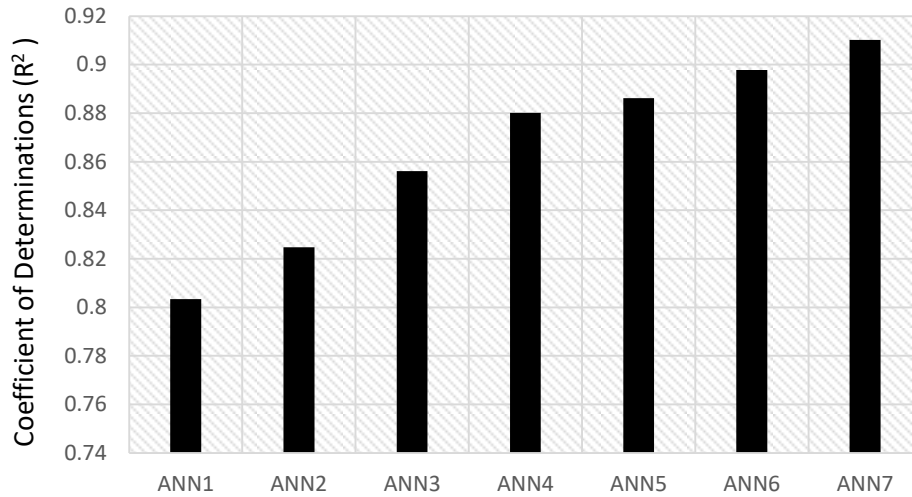
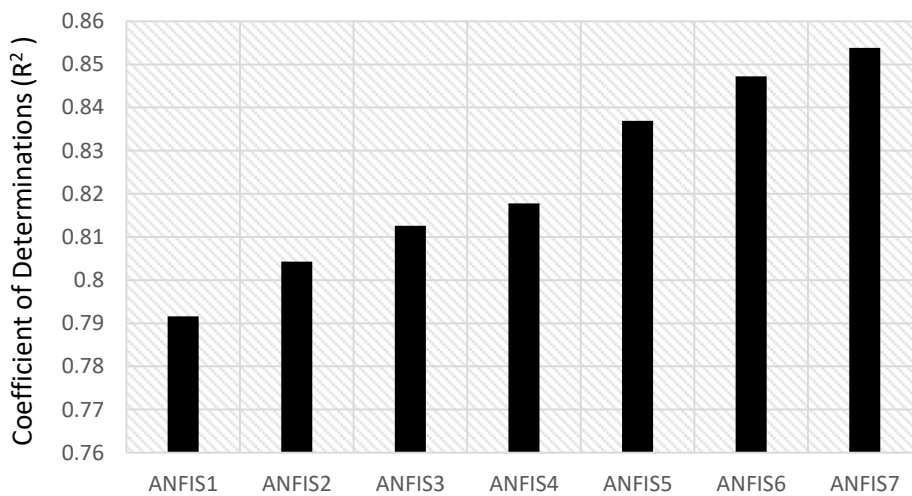
**Fig. 18.** Coefficient of Determinations ( $R^2$  values) for ANN1, ANN2, ANN3, ANN4, ANN5, ANN6, and ANN7.**Fig. 19.** Coefficient of Determinations ( $R^2$  values) for ANFIS1, ANFIS2, ANFIS3, ANFIS4, ANFIS5, ANFIS6, and ANFIS7.

As illustrated above, an increase in the number of input parameters would lead to an increase in the coefficient of determination. Consequently, the more input variables one can collect, the more accurate the prediction that can be produced for the compressive strength of concrete.

## 7. Conclusion

(1) ANFIS Model with  $R^2$  Value of 0.8538 is shown to be a capable model for predicting the compressive strength of recycled brick aggregate concrete. In addition, E value of 0.8531, MAPE (%) value of 12.7678, RMSE value of 5.1486, and MAE value of 3.8438 confirm this result.

(2) Artificial Neural Network Model with  $R^2$  value of 0.9102 as demonstrated is an excellent model for estimating the compressive strength of recycled brick aggregate concrete. Furthermore, E value of 0.8874, MAPE (%) value of 4.5232, RMSE value of 4.5067, and a MAE value of 1.0629 confirm this finding.

(3) Although, both ANFIS and ANN models are shown to be capable in estimating the compressive strength of concrete. ANN with  $R^2$  value of 0.9102 is comparably more proficient than ANFIS with  $R^2$  value of 0.8538 at predicting the compressive strength of RBAC.

(4) It is shown that both ANN and ANFIS models are better than the MLR model at predicting the compressive strength of concrete. However, the MLR model is still suitable for use in the preliminary mix design estimation of concrete, but for increased accuracy ANN and ANFIS models are ideal.

(5) The number of hidden neurons in the hidden layer has significant and direct impact on accuracy of prediction models. In this study, the compressive strength of concrete was estimated for various number of hidden nodes in the hidden layer. The formula  $2N+1$  was determined to be the most efficient equation at approximating this parameter.

(6) The Sensitivity Analysis (SA) on a dataset indicates that the number of input parameters are an important factor for increasing the accuracy of prediction models. In this study, it is shown that the more input parameters are present, the more accurate the result of the estimation model is.

## References

- [1] Debieb F, Kenai S. The use of coarse and fine crushed bricks as aggregate in concrete. *Constr Build Mater* 2008;22:886–93. <https://doi.org/10.1016/j.conbuildmat.2006.12.013>.
- [2] Khademi F, Jamal SM, Deshpande N, Londhe S. Predicting strength of recycled aggregate concrete using artificial neural network, adaptive neuro-fuzzy inference system and multiple linear regression. *Int J Sustain Built Environ* 2016;5:355–69.
- [3] Cachim PB. Mechanical properties of brick aggregate concrete. *Constr Build Mater* 2009;23:1292–7. <https://doi.org/10.1016/j.conbuildmat.2008.07.023>.
- [4] Miličević I. Fire resistance of concrete with crushed bricks and roof tiles 2014.
- [5] Khalaf FM, DeVenny AS. Recycling of demolished masonry rubble as coarse aggregate in



- concrete: Review. *J Mater Civ Eng* 2004;16:331–40. [https://doi.org/10.1061/\(ASCE\)0899-1561\(2004\)16:4\(331\)](https://doi.org/10.1061/(ASCE)0899-1561(2004)16:4(331)).
- [6] Kalman Šipoš T, Miličević I, Siddique R. Model for mix design of brick aggregate concrete based on neural network modelling. *Constr Build Mater* 2017;148:757–69. <https://doi.org/10.1016/j.conbuildmat.2017.05.111>.
- [7] Khatib JM. Properties of concrete incorporating fine recycled aggregate. *Cem Concr Res* 2005;35:763–9. <https://doi.org/10.1016/j.cemconres.2004.06.017>.
- [8] Naderpour H, Rafiean AH, Fakharian P. Compressive strength prediction of environmentally friendly concrete using artificial neural networks. *J Build Eng* 2018;16:213–9. <https://doi.org/10.1016/j.jobe.2018.01.007>.
- [9] Tavakoli D, Fakharian P, de Brito J. Mechanical properties of roller-compacted concrete pavement containing recycled brick aggregates and silica fume. *Road Mater Pavement Des* 2021:1–22. <https://doi.org/10.1080/14680629.2021.1924236>.
- [10] Poon CS, Chan D. The use of recycled aggregate in concrete in Hong Kong. *Resour Conserv Recycl* 2007;50:293–305. <https://doi.org/10.1016/J.RESCONREC.2006.06.005>.
- [11] Poon CS, Chan D. Effects of contaminants on the properties of concrete paving blocks prepared with recycled concrete aggregates. *Constr Build Mater* 2007;21:164–75. <https://doi.org/10.1016/J.CONBUILDMAT.2005.06.031>.
- [12] Sadrmomtazi A, Sobhani J, Mirgozar MA. Modeling compressive strength of EPS lightweight concrete using regression, neural network and ANFIS. *Constr Build Mater* 2013;42:205–16. <https://doi.org/10.1016/J.CONBUILDMAT.2013.01.016>.
- [13] Yuan Z, Wang L-N, Ji X. Prediction of concrete compressive strength: Research on hybrid models genetic based algorithms and ANFIS. *Adv Eng Softw* 2014;67:156–63. <https://doi.org/10.1016/J.ADVENGSOFT.2013.09.004>.
- [14] Khademi F, Akbari M, Jamal SM, Nikoo M. Multiple linear regression, artificial neural network, and fuzzy logic prediction of 28 days compressive strength of concrete. *Front Struct Civ Eng* 2017;11:90–9. <https://doi.org/10.1007/s11709-016-0363-9>.
- [15] Ahmadi-Nedushan B. Prediction of elastic modulus of normal and high strength concrete using ANFIS and optimal nonlinear regression models. *Constr Build Mater* 2012;36:665–73. <https://doi.org/10.1016/j.conbuildmat.2012.06.002>.
- [16] Topçu IB, Saridemir M. Prediction of mechanical properties of recycled aggregate concretes containing silica fume using artificial neural networks and fuzzy logic. *Comput Mater Sci* 2008;42:74–82. <https://doi.org/10.1016/J.COMMATSCI.2007.06.011>.
- [17] Duan ZH, Kou SC, Poon CS. Prediction of compressive strength of recycled aggregate concrete using artificial neural networks. *Constr Build Mater* 2013;40:1200–6. <https://doi.org/10.1016/j.conbuildmat.2012.04.063>.
- [18] Dantas ATA, Batista Leite M, De Jesus Nagahama K. Prediction of compressive strength of concrete containing construction and demolition waste using artificial neural networks. *Constr Build Mater* 2013;38:717–22. <https://doi.org/10.1016/J.CONBUILDMAT.2012.09.026>.
- [19] Kar S, Pandit AR, Biswal KC. Prediction of FRP shear contribution for wrapped shear deficient RC beams using adaptive neuro-fuzzy inference system (ANFIS). *Structures* 2020;23:702–17. <https://doi.org/10.1016/J.ISTRUC.2019.10.022>.
- [20] Naderpour H, Poursaeidi O, Ahmadi M. Shear resistance prediction of concrete beams reinforced by FRP bars using artificial neural networks. *Meas J Int Meas Confed* 2018;126:299–308. <https://doi.org/10.1016/j.measurement.2018.05.051>.
- [21] Ahmadi M, Naderpour H, Kheyroddin A. ANN Model for Predicting the Compressive Strength of Circular Steel-Confining Concrete. *Int J Civ Eng* 2017;15:213–21. <https://doi.org/10.1007/s40999-016-0096-0>.

- [22] Naderpour H, Rezazadeh Eidgahee D, Fakharian P, Rafiean AH, Kalantari SM. A new proposed approach for moment capacity estimation of ferrocement members using Group Method of Data Handling. *Eng Sci Technol an Int J* 2020;23:382–91. <https://doi.org/10.1016/j.jestch.2019.05.013>.
- [23] Jahangir H, Rezazadeh Eidgahee D. A new and robust hybrid artificial bee colony algorithm – ANN model for FRP-concrete bond strength evaluation. *Compos Struct* 2021;257:113160. <https://doi.org/10.1016/J.COMPSTRUCT.2020.113160>.
- [24] Khotbehsara MM, Miyandehi BM, Naseri F, Ozbakkaloglu T, Jafari F, Mohseni E. Effect of SnO<sub>2</sub>, ZrO<sub>2</sub>, and CaCO<sub>3</sub> nanoparticles on water transport and durability properties of self-compacting mortar containing fly ash: Experimental observations and ANFIS predictions. *Constr Build Mater* 2018;158:823–34. <https://doi.org/10.1016/J.CONBUILDMAT.2017.10.067>.
- [25] Abraham A. Adaptation of Fuzzy Inference System Using Neural Learning 2005:53–83. [https://doi.org/10.1007/11339366\\_3](https://doi.org/10.1007/11339366_3).
- [26] Sobhani J, Najimi M, Pourkhorshidi AR, Parhizkar T. Prediction of the compressive strength of no-slump concrete: A comparative study of regression, neural network and ANFIS models. *Constr Build Mater* 2010;24:709–18. <https://doi.org/10.1016/j.conbuildmat.2009.10.037>.
- [27] Pala M, Özbay E, Öztaş A, Yuce MI. Appraisal of long-term effects of fly ash and silica fume on compressive strength of concrete by neural networks. *Constr Build Mater* 2007;21:384–94. <https://doi.org/10.1016/J.CONBUILDMAT.2005.08.009>.
- [28] Alshihri MM, Azmy AM, El-Bisy MS. Neural networks for predicting compressive strength of structural light weight concrete. *Constr Build Mater* 2009;23:2214–9. <https://doi.org/10.1016/J.CONBUILDMAT.2008.12.003>.
- [29] Behfarnia K, Khademi F. A COMPREHENSIVE STUDY ON THE CONCRETE COMPRESSIVE STRENGTH ESTIMATION USING ARTIFICIAL NEURAL NETWORK AND ADAPTIVE NEURO-FUZZY INFERENCE SYSTEM. *Iran Univ Sci Technol* 2017;7:71–80.
- [30] Mathworks I. MATLAB and statistics toolbox release 2012b. Natick (Massachusetts, United States) 2012.