

Pedelec Li-ION battery lifetime

Glavaš, Hrvoje; Karakašić, Mirko; Petrović, Ivica; Vidaković, Držislav

Source / Izvornik: **Annals of the Faculty engineering Hunedoara, 2019, 17, 35 - 40**

Journal article, Published version

Rad u časopisu, Objavljena verzija rada (izdavačev PDF)

Permanent link / Trajna poveznica: <https://um.nsk.hr/um:nbn:hr:133:737896>

Rights / Prava: [In copyright](#) / [Zaštićeno autorskim pravom.](#)

Download date / Datum preuzimanja: **2025-02-22**



GRAĐEVINSKI I ARHITEKTONSKI FAKULTET OSIJEK
Faculty of Civil Engineering and Architecture Osijek

Repository / Repozitorij:

[Repository GrAFOS - Repository of Faculty of Civil Engineering and Architecture Osijek](#)



¹Hrvoje GLAVAŠ, ²Mirko KARAKAŠIĆ, ¹Ivica PETROVIĆ, ³Držislav VIDAKOVIĆ

PEDELEC LI-ION BATTERY PACK LIFETIME

¹University of Osijek, Faculty of Electrical Engineering, Computer Science and Information Technology Osijek, Osijek, CROATIA²University of Osijek, Mechanical Engineering Faculty, Slavonski Brod, CROATIA³University of Osijek, Faculty of Civil Engineering Osijek, Osijek, CROATIA

Abstract: Energy policy of EU promotes electro-mobility, especially the use of bicycles and electric bicycles. PEDELEC is a form of an electric bicycle that does not require a registry plate, and with a battery power 250 W electric motor helps the driver to overcome the altitude differences and influence of the wind. Batteries for electric bicycles are based on Li-Ion technology. Battery packs are made of standard cells that have a lifecycle of 1000 cycles. In realistic exploration conditions, the lifecycle is four years and up to a third of the declared cycle of use. The reason for this is the climatic conditions which lead to increased temperatures in usage and charging temperatures, which significantly reduce their life cycle. Paper on a practical example shows the dynamics of PEDELEC usage, energy needs for specific route characteristics, as well as changes in the thermal pattern of the battery and its condition after 4 years of use. The analysis was performed with Non-Destructive Testing (NDT) using infrared thermography, which confirmed the inhomogeneity of thermal patterns and the moment of final battery failure.

Keywords: Li-Ion, 18650, battery pack, PEDELEC, thermography

1. INTRODUCTION

Energy policy of the European Union promotes the use of electric vehicles. In order to reduce import of crude oil, CO₂ emissions and congestion in large cities. The aim of the European Union's land transport policy is to promote mobility that is efficient, safe, secure and environmentally friendly. London is the first city to introduce Congestion charging zone in 2003. The charge covers a 21 km² area in London. If you enter the zone between 7am and 6pm on a weekday, you pay a flat daily rate. The charge has risen from 5 £ in 2003, 7.50 £ in 2006 to 11.50 £ in 2018. Residents receive a 90 % discount and registered disabled people can travel for free. Emergency services, motorcycles, taxis and minicabs are exempt. Fully electric vehicles and hydrogen fuel cell cars are exempt from this charge, along with a number of efficient hybrids. With the aim of reducing traffic congestion, the use of bicycles and electric bicycles is promoted. 40000 vehicles drive into it per hour in the morning peak. Since implementation, vehicle delays have reduced by 26 % inside the charging zone and the bus fleet and ridership have increased significantly, [1].

Aim of this paper is to present case study of four years usage of electric bicycle PEDELEC on city area with special reference to the weakest element of the electrical mobility, battery. PEDELEC (pedal electric cycle) is name for bicycle with an electric motor supporting the ride. Electric motor with maximum power of 250 W helps the driver until reach the speed of 25 km/h. It is the only form of electric vehicle in EU countries that does not require registration.

2. PRACTICAL USAGE OF PEDELEC IN THE AREA OF CITY OSIJEK

— Basic information on daily transport needs

Cycling in Osijek represents a way of life and a favorite recreation on 40 kilometers of cycling trails. The city is located on an international bicycle route along the Danube that stretches from Germany across Austria, Hungary, Serbia, Romania and Bulgaria. The European bicycle route Euro Velo 6 connects Osijek with Budapest and Novi Sad. The second route nearby is the Euro Velo 13, the so-called Iron Curtain Route [2]. For daily traffic needs, in this research, was used Kalkhoff's electric bicycle. This bicycle has 8FUN drive engine on the front axle, power 250 W and Li-Ion 36 V, 9 Ah battery (Figure 1).



Figure 1. Kalkhoff PEDELEC used for research

A typical day-trip on the way from home to work (Faculty of Electrical Engineering, Computer Science and Information Technology Osijek) as well as the speeds in (km/h) on individual parts of route can be seen in Figure 2.



Figure 2. The basic daily route of PEDELEC and the driving dynamics of the daily route, source [2]

Average traffic speeds of PEDELEC goes from 20 to 22.8 km/h, [3]. Average traffic speeds in EU cities: London (19 km/h), Berlin (24 km/h), Warsaw (26 km/h), Edinburgh (30 km/h), Rome (30 km/h), Glasgow (30 km/h), Bristol (31 km/h), Paris (31 km/h), Belfast (32 km/h), Munich (32 km/h), Amsterdam (34 km/h), Barcelona (35 km/h). Conducted measurements during May 2015 indicate that the average speed of traffic in Osijek by car (38.4 - 39.7 km/h) and bicycle (12.5 - 14.6 km/h). Average traffic speed with PEDELEC and car in the populated area of high traffic density is similar [3]. The experiences from the literature, calculations by ExtraEnergy based on market values. As a basis for calculation, the lifecycle of PEDELEC including batteries was taken as 4 years or 19200 km, alongside a kWh price of 0.2 €, plus annual repair and spares cost of 150 €. Alternatively, the figure of € 40 per month for motivational leasing via an employer could be used, in which a PEDELEC to a value of € 1800 would be leased over a period of three years for 38.01 € per month, [4]. Practical experiences of authors are presented in Table 1. Battery analyzed in this paper provided, during 4 years, 2543 km, while the experiences of other users of a similar bicycle that used only the lowest amount of engine power tell about 7000 km before the battery is dead. In the first years of use, the rechargeable battery of the test bicycle was allowing a movement radius of 30 - 40 km. In the fourth year, autonomy fell up to 15 km. Then in just a few recharges, on the radius of 7 km and then the battery has died. The price of the new battery is 351 €. This makes the price of the mileage, on the test model, higher than the cost of fuel in a car (0.08 €/km).

Table 1. The mileage of the battery over the lifetime

Year	Test bike Kalkhoff PEDELEC	Similar bike with same battery
2014	20 km	1000 km
2015	1093 km	2500 km
2016	950 km	1500 km
2017	300 km	2000 km
2018	180 km	0 km
Sum	2543 km	7000 km
€/km	0.14	0.05

— PEDELEC energy needs on daily route

When driving a bicycle, the driver often invests extra energy in overcoming air resistance in the case of wind and potential differences in the case of a hill. The average recreational cyclist developing a power of 100 W, when in good form it can go even up to 200 W. Professional cyclist develop from 200 W up to 300 W. In races, 400 W was recorded in continuity at a distance of 14 km [3]. Needs of driving power are best described in Figure 3 left [5]. Figure 3 right presents speed and proportional energy demand from 75 kg driver with a bike by primary resistance forces during a state of 300 W constant power cycling, source professional training systems, scientific training for cyclist and multisport athletes.

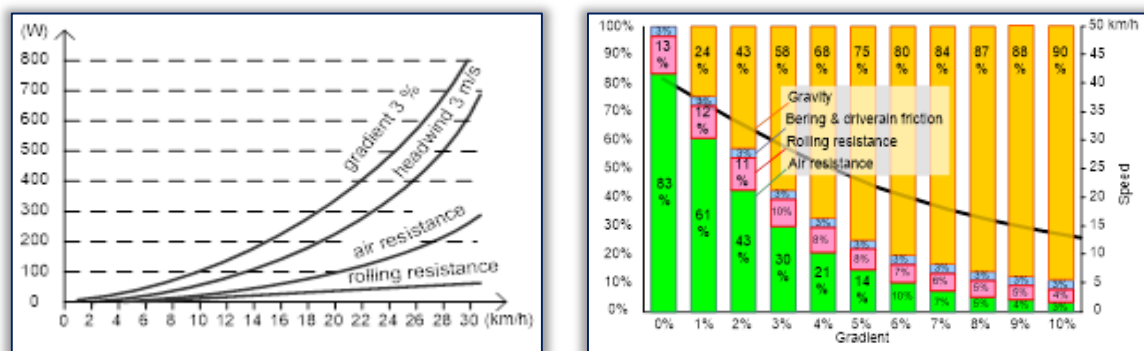

Figure 3. Required driving force for different speeds and proportional energy demand by primary resistance forces during steady-state cycling

The mathematical description of the needed power in relation to the variables as bike speed, wind speed, mass and resistance is defined by the expression (1). Trajectory dependencies of particular variables are detail described in [6].

$$W = \left[K_a (V + V_w)^2 + g(m_r + m_b)(s + C_r) \right] \cdot V \quad (1)$$

where: W - shaft power s - gradient (%) (5 % = 0.05) m_r - driver mass
 K_a - drag factor C_r - rolling resist. coefficient 0.003 m_b - bike mass
 V - bike speed V_w - headwind speed g - 9.81 m/s²

3. LI-ION BATTERY

The demand for PEDELEC started in 2005 mainly thanks to the widespread use of Li-Ion batteries [3]. Li-Ion batteries, thanks to a higher energy density, are currently the best solution for electrical mobility (Figure 4).

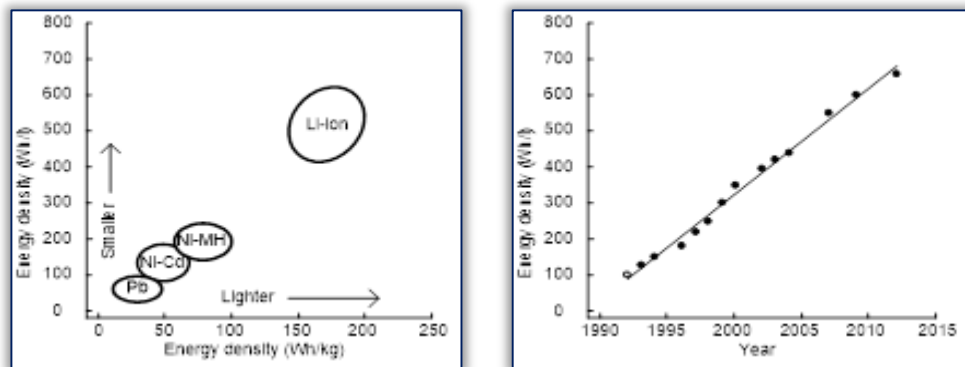

Figure 4. Energy density trend and increase in performances of 18650 Li-Ion cell [7]

In Li-Ion batteries (LiBs), Li⁺ ions move from the positive electrode to the negative electrode upon charging, and reversely upon discharge, as shown in Figure 5. The negative electrode is usually carbon-graphite (LiC₆). There are different kinds of positive electrodes: the lamellar compounds (archetype LiCoO₂), the spinel compounds (archetype LiMn₂O₄) and the olivine compounds (LiFePO₄). The electrolyte is either liquid, made of carbonates plus a Li salt, or a solid (a conductive polymer). Liquid electrolyte allows for much greater power density because the carbonates are good ionic conductors. Liquid electrolyte major problem is that boil at about 90°C, and in practice, these batteries can be operated in the temperature range of 20 to +60 °C. At higher temperatures, the electrolyte deteriorates; at lower temperatures, the conductivity is too small. With a solid-state battery, the conductivity of the electrolyte is small so that the battery need to heat to the 90 °C. Battery pack mainly is make from standardized Li-Ion cells, Fig. 5, [8]. The first LIB generation (Sony Corporation, 1991) was produced in a standardized format, the well-known 18650 cylindrical cell [9].



Figure 5. Construction and interior design of a 18650 cylindrical battery

Lithium-ion chemistries tend to operate best between about 10 and 35 °C; this is referred to as the optimal temperature range. This is where you want the batteries to be at most of the time. However, most all lithium-ion chemistries will still operate down to about -20 °C and up to about 45 °C; this is known as the operational range. In this temperature range, no reduction in battery life would be expected to be experienced during normal operation. Between -20 and -40 °C the electrolytes may begin to freeze and the cold temperatures increase the impedance within the cell thereby resisting the flow of ions and reducing capacity and performance, and above 60 °C many lithium-ion cell chemistries begin to get more unstable; this is known as the survival temperature range, [7].

4. BATTERY PACK

Battery pack for PEDELEC is usually 36V. To get this voltage, it is necessary to connect 10 batteries in the series. In order to provide sufficient energy, certain elements may contain multiple parallel cells. The analyzed pack contains 40 CGR18650CG Li-Ion MH12210 cells. Cell nominal voltage is 3.6 V and with capacity 2250 mAh gives a pack capacity of 9 Ah.

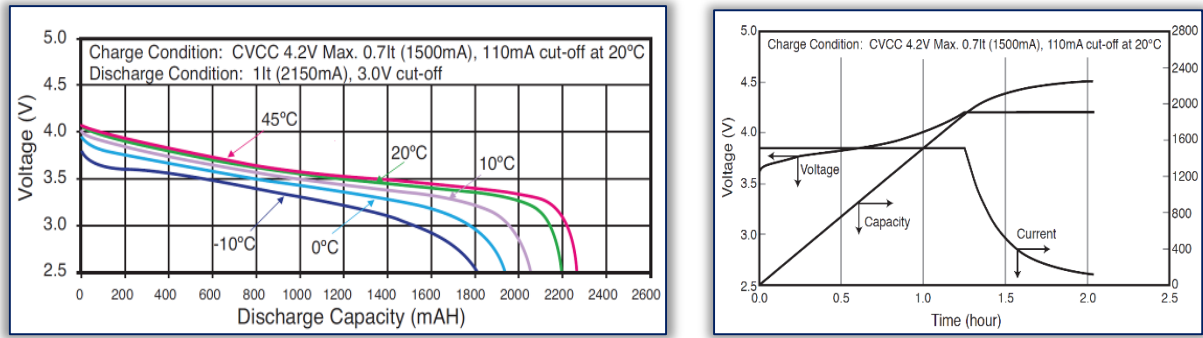

Figure 6. Panasonic CGR18650CG characteristic from data sheet

It is important that all cells, inside battery pack, are similar characteristics (inner resistance) because it depends on lifecycle of battery pack [10]. As some of the batteries in the same series differ in one another, it is necessary to monitor the charging cycles because Li-Ion batteries are sensitive to overflow which can lead to ignition. Battery Management System (BMS) is the basic component of each battery pack. Electric bicycles do not have a Thermal Management System (TMS) which can cause a temperature difference of about 2 – 3 °C from the coolest cell to the warmest cell. In the case of cars and larger battery packs the difference can be as much as 6 – 8 °C. The reason why this is important is that a large temperature gradient between the cells will cause the cells to age at different rates, more information in [11]. Hotter cells will age faster than the cooler cells, and if there is a large gradient, this could mean that the battery’s calendar life will be reduced prematurely [7].

BMS serves to balance energy of individual cells because the behavior of the group is complex [12]. Balancing can be active and passive. In practice, it is most passive because the price of active balancers is not justified by energy savings. The passive cells balancer that fill individual cell in the charging process before the other, i.e. achieve the 4.2 V voltage slowly empties over the resistor that is connected in parallel with the cell. Figure 7 shows the location of BMS and individual cells in the analyzed battery pack as well as the schematic layout of the BMS compound.

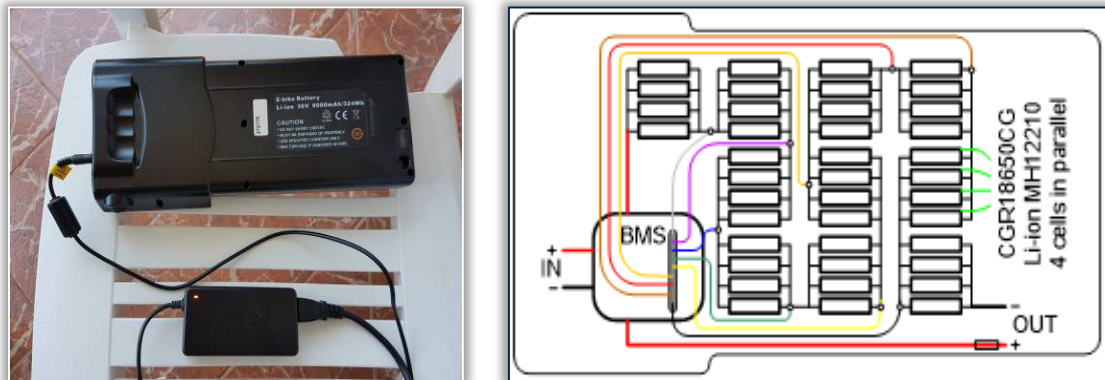

Figure 7. Battery photo with charger and schematic representation of the BMS in the battery pack (bottom view)

The premature destruction of the battery led to the use of charging immediately after the run, which was mainly during high outdoor temperatures. The lack of thermal management and the unequal distribution of dissipation led to a different aging of the cells, which can be seen from the thermal form in Figure 8.

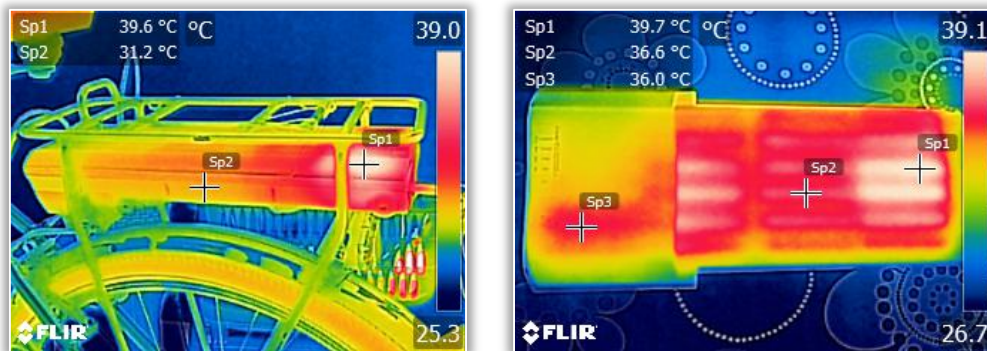

Figure 8. Uneven thermal pattern in operation (top view)

The temperature values in Fig. 8 show a difference in the battery temperature of 3.7 °C, while the difference to the housing takes up to 8.4 °C. Older cells with lower capacity have higher internal resistance. Because of this, good cells take over most

of the current on themselves. This leads to their heating and aging. Batteries in the battery pack are set in two levels, so you need to analyze both sides of the battery pack. Figure 9 (left) shows the upper side of the battery and the lower side (right). Figure 9 can clearly estimate the location of individual cells as well as assume their qualitative status.

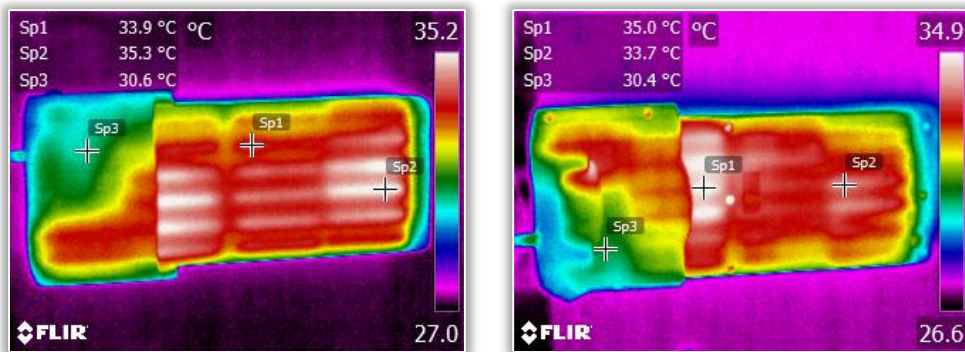

Figure 9. Battery pack thermal pattern in charging process

When after 4 years the battery could not exceed more than 800 meters, we carried out an additional thermographic analysis and determined the existence of a hot spot. Figure 10 shows a thermal hot spot on the cells that have stopped working. Hot spots represent the healthy cells that are in parallel with the defective cell and conduct a current of the serial circuit.

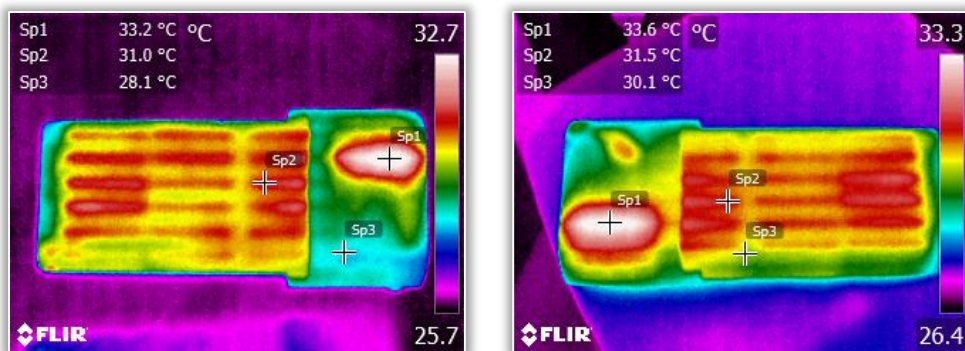

Figure 10. Battery pack thermal pattern at end of lifetime

Taking average PEDELEC speed and radius of autonomy, it is possible to estimate the average engine power. The drop in capacity that is manifested through reduction of autonomy is shown in Table 2 as an estimate of the capacity of a battery pack and of a particular cell.

Table 2. Battery pack capacity estimation based on PEDELEC average speed and range

PEDELEC range (km)	Operating time (h)	Battery pack capacity (Ah)	Average power (W)	Cell capacity (mAh)	Percentage of initial battery capacity
40	1.75	9.00	185	2250	100
15	0.66	3.38	185	844	38
7	0.31	1.58	185	394	18

5. CONCLUSIONS

Batteries are the basic element of electro-mobility. With the launch of the Li-Ion battery on the market, the intense development of various forms of electric vehicles begins. For the needs of electric bicycles, PEDELEC especially, various battery packs are developed based on standard 18650 cells. In order to achieve the necessary voltage, the battery cells are put in series. Battery capacity increases by joining individual cells in parallel. The difference in characteristics and the need for voltage control, require BMS in each battery pack. BMS controls the voltage of an individual cell in the serial connection so that there is no overcharge and fire.

Manufacturers declare battery life over the number of charging and discharging cycles. The number of the lifecycle for Li-Ion battery is 1000. Under realistic conditions of exploitation, battery life is 4 years. Based on two practical examples, the charging number is estimated to be from 120 to 200. Main cause of the deviation from the manufacturer's reference is the temperature regime of exploitation and charging. Temperatures that are during charging process higher from standard testing temperature, significantly short the battery life cycle. On analyzed batteries, we can see that the capacity drops by an average of 20% per year and the end of battery use occur suddenly. Infrared thermography, as an NDT method, can help to detect the inhomogeneity of the thermal pattern which is a consequence of uneven aging of individual cells in the battery pack.

Note:

This paper is based on the paper presented at IIZS 2018 – The 8th International Conference on Industrial Engineering and Environmental Protection, organized by Technical Faculty “Mihajlo Pupin” Zrenjanin, University of Novi Sad, in Zrenjanin, SERBIA, 11–12 October, 2018.

References

- [1] Nicole Badstuber, London congestion charge has been a huge success. It's time to change it, www.citymetric.com, March 12, 2018
- [2] Hrvoje Glavaš, Dražen Dorić, Stjepan Aračić, Practical Application of PEDELEC in the City of Osijek, 38th Conference on Transportation Systems with International Participation Automation in Transportation 2018, 14.- 18.11.2018. Osijek – Budapest, Croatia -Hungary
- [3] Hrvoje Glavaš, Tomislav Barić, Tomislav Keser "Pedelec - Pedal Electric Cycle" 35th Conference on Transportation Systems with International Participation Automation in transportation 2015, Zagreb – London, Croatia - England, 03.-08.11.2015.
- [4] Leaserad at Go Pedelec MDM Workshop Stuttgart. 14th June 2012, page 22
- [5] W. Wijk, Bicycle Traffic Planning and Design, Warszawa, Poland, May 25, 2012
- [6] D. G. Wilson, Bicycling Science 3 ed., MIT Press Cambridge, London, 2004.
- [7] John Warner, The Handbook of Lithium-Ion Battery Pack Design Chemistry, Components, Types and Terminology, Elsevier, 2015
- [8] <https://spectrum.ieee.org/ns/images/sep07/images/lithf2.gif>
- [9] Alejandro A. Franco editor, Rechargeable Lithium Batteries, Elsevier Ltd. Woodhead Publishing ISBN 978-1-78242-090-3, 2015
- [10] Radu Gogoana, Matthew B. Pinson, Martin Z. Bazant, Sanjay E. Sarma: "Internal resistance matching for parallel-connected lithium-ion cells and impacts on battery pack cycle life" Journal of Power Sources 252 (2014) 8-13
- [11] Noshin Omar et al., Lithium iron phosphate based battery – Assessment of the aging parameters and development of cycle life model, Applied Energy, Volume 113, 2014, Pages 1575-1585, ISSN 0306-2619, DOI: /10.1016/j.apenergy.2013.09.003.
- [12] Matthieu Dubarry, Nicolas Vuillaume, Bor Yann Liaw, From single cell model to battery pack simulation for Li-ion batteries, Journal of Power Sources, Volume 186, Issue 2, 2009, ISSN 0378-7753, DOI: 10.1016/j.jpowsour.2008.10.051.



ISSN 1584 - 2665 (printed version); ISSN 2601 - 2332 (online); ISSN-L 1584 - 2665

copyright © University POLITEHNICA Timisoara, Faculty of Engineering Hunedoara,

5, Revolutiei, 331128, Hunedoara, ROMANIA

<http://annals.fih.upt.ro>